



PORSCHE

Modellübersicht Porsche Classic

Modellbezeichnung	Modelljahr (MJ)	Modellbezeichnung	Modelljahr (MJ)
356 Urmodell/356 A/356 B/356 C:		944:	
356 Coupé, alle Derivate	MJ 1948 bis 1965	944 Coupé, alle Derivate	MJ 1982 bis 1991
356 Cabriolet, Speedster American-Roadster, alle Derivate	MJ 1948 bis 1965	944 Cabriolet, alle Derivate	MJ 1989 bis 1991
356 Convertible-D (Hardtop)/ Hardtop-Cabriolet, alle Derivate	MJ 1952 bis 1965	959:	
550:		959 Coupé, alle Derivate	MJ 1986 bis 1988
550 Coupé, alle Derivate	MJ 1952 bis 1957	911 (964):	
550 Spyder, alle Derivate	MJ 1953 bis 1957	911 Coupé, alle Derivate	MJ 1989 bis 1994
911 Urmodell:		911 Targa, alle Derivate	MJ 1990 bis 1994
911 Coupé, alle Derivate	MJ 1965 bis 1973	911 Cabriolet, Speedster alle Derivate	MJ 1990 bis 1994
911 Targa, alle Derivate	MJ 1965 bis 1973	911 Turbo, alle Derivate	MJ 1990 bis 1994
911 G-Modell:		968:	
911 Coupé, alle Derivate	MJ 1974 bis 1989	968 Coupé, alle Derivate	MJ 1991 bis 1995
911 Targa, alle Derivate	MJ 1974 bis 1989	968 Cabriolet, alle Derivate	MJ 1991 bis 1995
911 Cabriolet, alle Derivate	MJ 1983 bis 1989	911 (993):	
911 G-Modell Turbo (930):		911 Coupé, alle Derivate	MJ 1994 bis 1998
911 Coupé, alle Derivate	MJ 1975 bis 1989	911 Targa, alle Derivate	MJ 1994 bis 1998
911 Targa, alle Derivate	MJ 1986 bis 1989	911 Cabriolet, alle Derivate	MJ 1994 bis 1998
911 Cabriolet, alle Derivate	MJ 1986 bis 1989	Boxster (986):	
912:		Boxster Cabriolet, alle Derivate	MJ 1997 bis 2004
912 Coupé, alle Derivate	MJ 1965 bis 1969	911 (996):	
912 Coupe E, alle Derivate	MJ 1976	911 Coupé, alle Derivate	MJ 1998 bis 2005
912 Targa, alle Derivate	MJ 1965 bis 1969	911 Targa, alle Derivate	MJ 1998 bis 2005
914:		911 Cabriolet, alle Derivate	MJ 1998 bis 2005
914 Targa, alle Derivate	MJ 1970 bis 1976	980:	
924:		980 Carrera GT, Cabriolet, alle Derivate	MJ 2003 bis 2006
924 Coupé, alle Derivate	MJ 1976 bis 1988		
928:			
928 Coupé, alle Derivate	MJ 1977 bis 1995		

Rechtlicher Hinweis:



PORSCHE

Rechtlicher Hinweis:

Die Porsche Rettungsdatenblätter wurden ausschließlich für Rettungsfachkräfte erstellt, die über eine entsprechende berufliche Ausbildung auf dem Gebiet der technischen Personenrettung aus Fahrzeugen nach Verkehrsunfällen verfügen, und dürfen ausschließlich zu diesem Zweck genutzt werden.

Sie beinhalten u. a. Informationen zur Karosseriebeschaffenheit, zu passiven Sicherheitssystemen sowie alternativen Antriebssystemen und stellen die maximal möglichen Ausstattungsvarianten dar.

Porsche ist kein Experte für die Durchführung von Rettungsaktionen. Deshalb müssen alle Rettungskräfte diese Informationen vor einem Rettungseinsatz beurteilen und auf Grund ihres Fachwissens Strategien entwerfen und Entscheidungen treffen. Wir empfehlen allen Rettungskräften, im Rahmen ihrer Übungen repräsentative Fahrzeuge von Porsche zu untersuchen, um diese Informationen in vollem Umfang zu verstehen.

Das Werk einschließlich seiner Teile ist urheberrechtlich geschützt. Jede kommerzielle Verwertung oder Nutzung bedarf der vorherigen schriftlichen Zustimmung der Porsche AG. Dies gilt insbesondere für Vervielfältigung, Verarbeitung, Bearbeitung, Übersetzung, Mikroverfilmung und die Einspeicherung und/oder Verarbeitung in elektronischen Systemen, einschließlich Datenbanken und Online-Diensten.

Inhaltliche Anpassungen bzw. Änderungen der Rettungsdatenblätter behält sich die Porsche AG ausdrücklich jederzeit vor. Die Informationen waren zum Zeitpunkt der Erstellung aktuell. Porsche schließt jegliche Verpflichtung zur Aktualisierung, Änderung oder zum Ersetzen dieser Informationen aus.



Porsche AG, 356 Urmodell, 356 A, 356 B, 356 C

Coupé, alle Derivate,

PORSCHE MJ 1948 bis MJ 1965

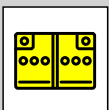
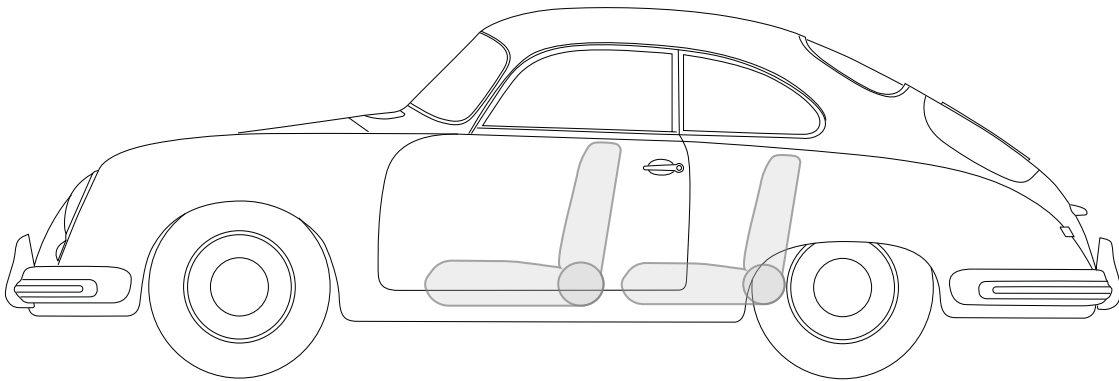
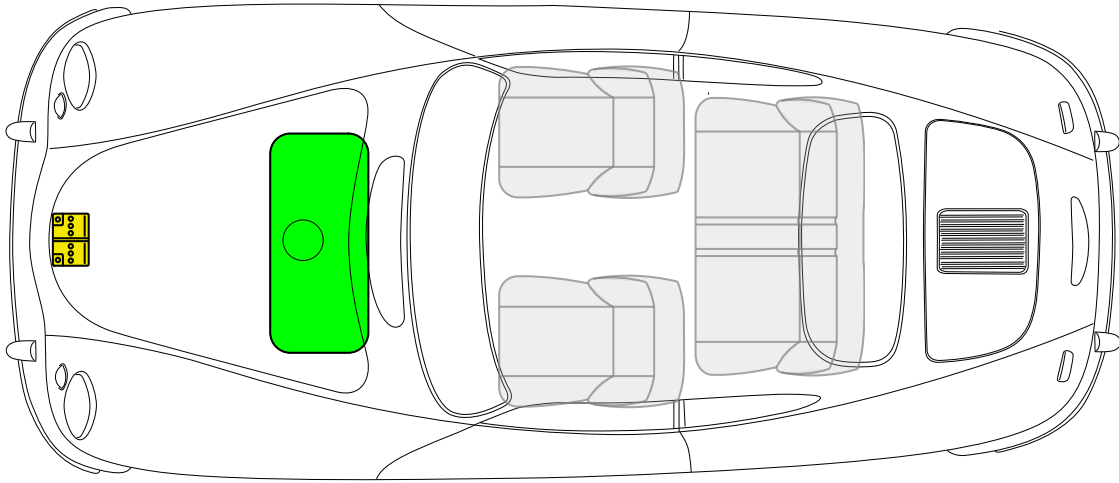

Batterie

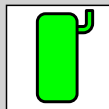

Kraftstofftank



**Porsche AG, 356 Urmodell, 356 A, 356 B, 356 C
Cabriolet, Speedster/American-Roadster, alle Derivate,
MJ 1948 bis MJ 1965**

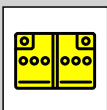
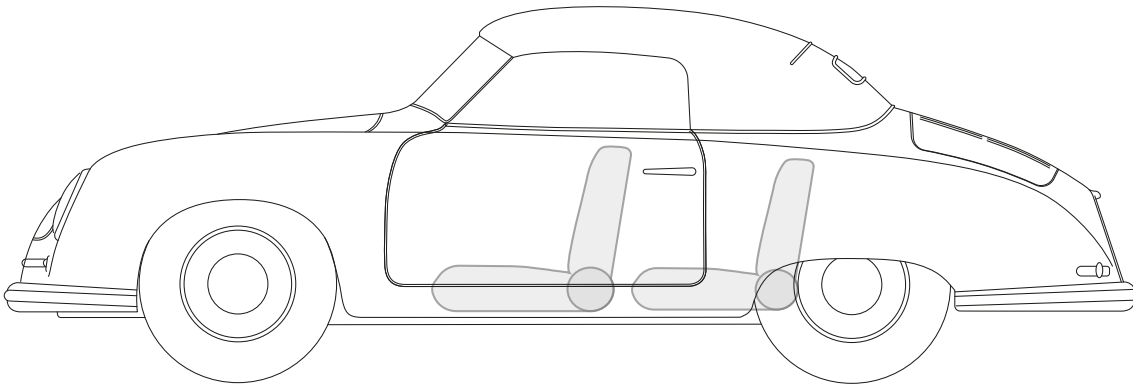
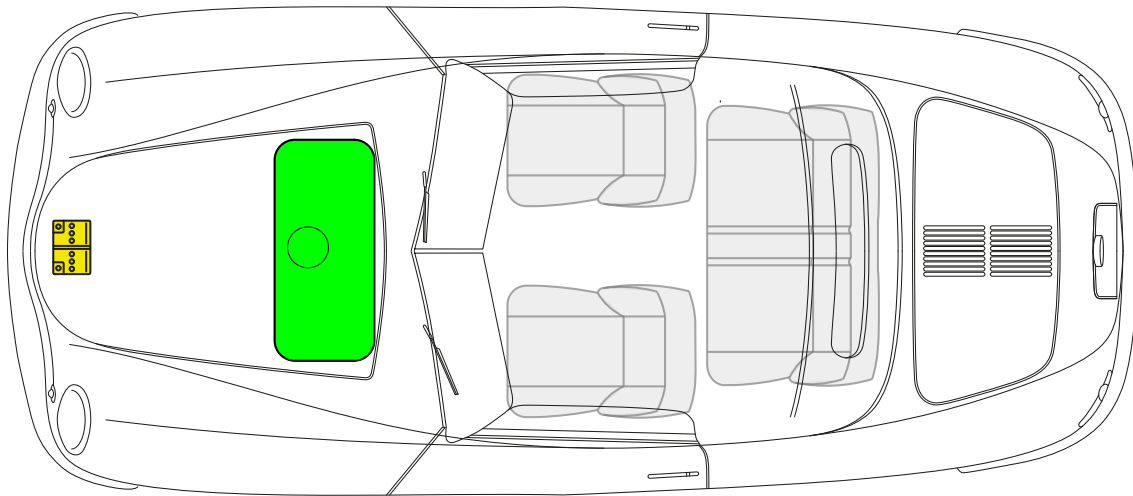

Batterie

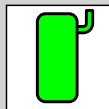

Kraftstofftank



**Porsche AG, 356 Urmodell, 356 A, 356 B, 356 C
Convertible-D (Hardtop), Hardtop-Cabriolet, alle Derivate ,
MJ 1952 bis MJ 1965**

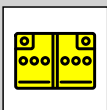
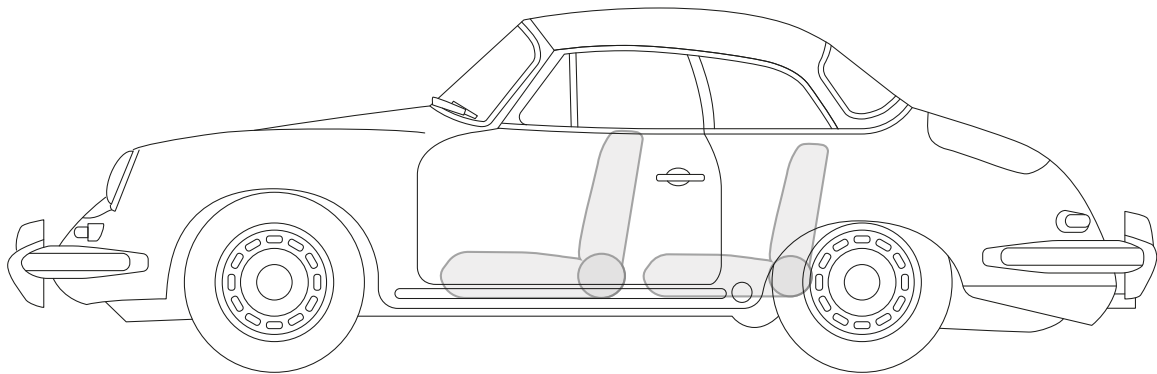
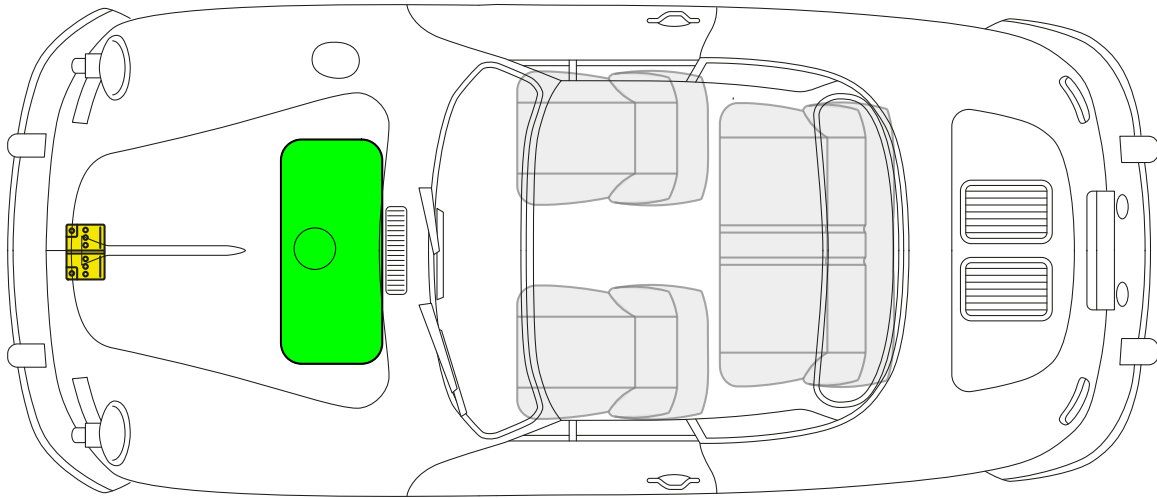

Batterie

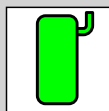

Kraftstofftank



Porsche AG, 550, Coupé, alle Derivate

PORSCHE MJ 1952 bis MJ 1957

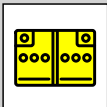
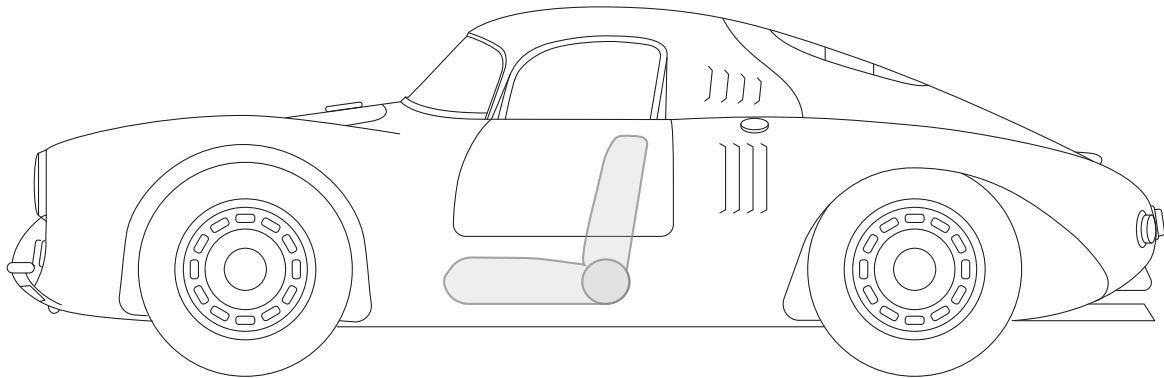
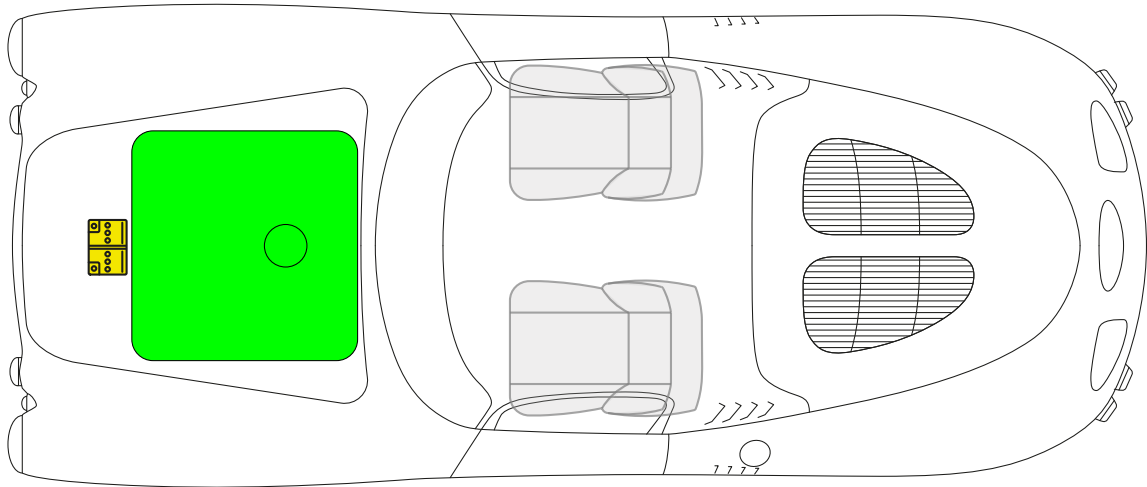

Batterie

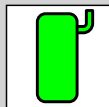

Kraftstofftank



**Porsche AG, 550, Spyder,
alle Derivate**

PORSCHE MJ 1953 bis MJ 1957

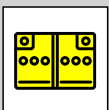
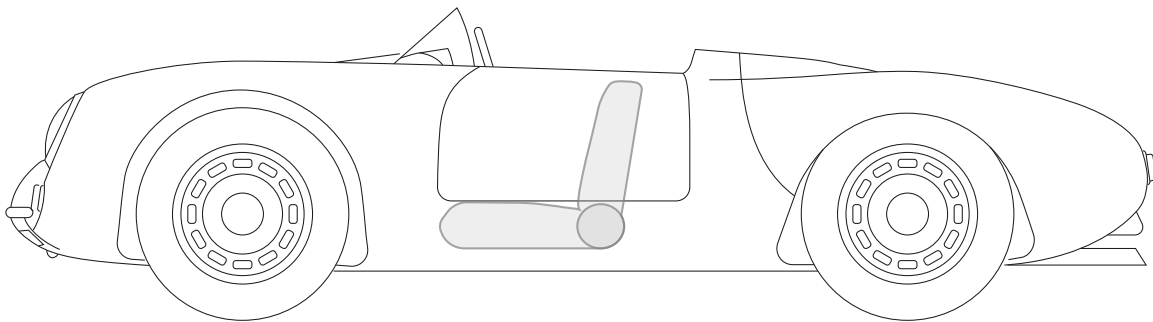
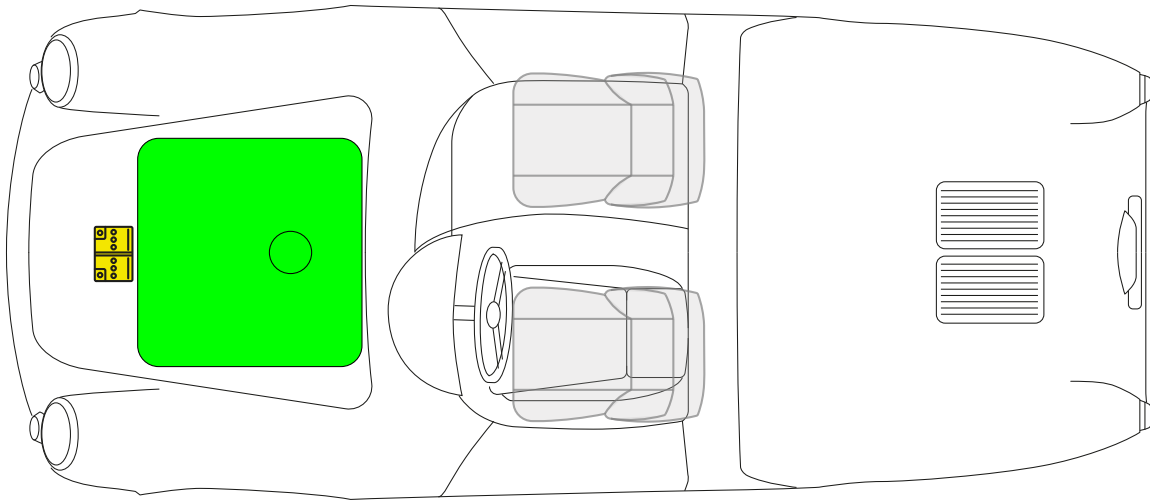

Batterie

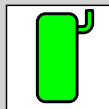

Kraftstofftank



Porsche AG, 911 Urmodell, Coupé, alle Derivate

PORSCHE MJ 1965 bis MJ 1973

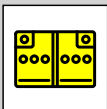
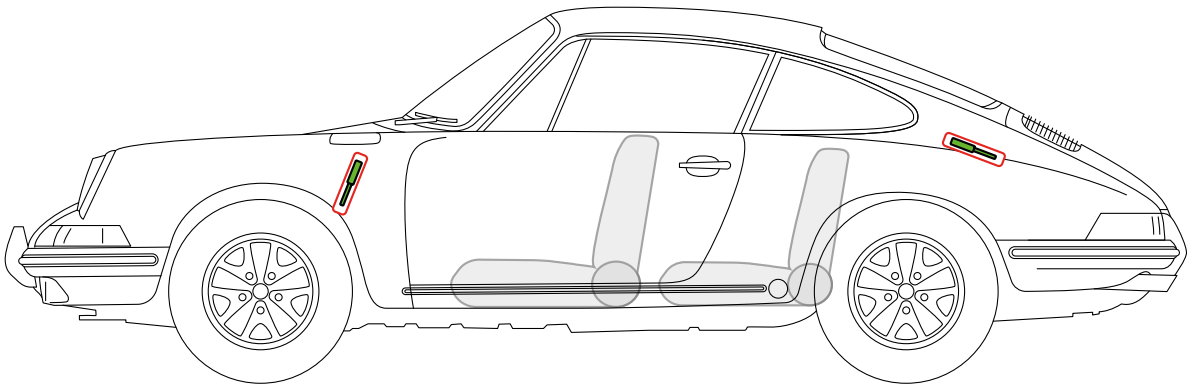
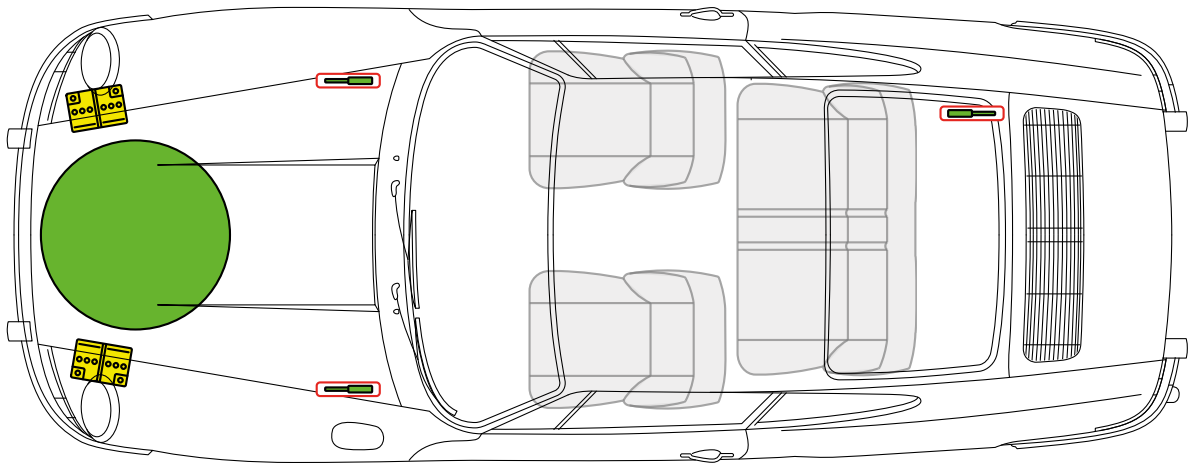
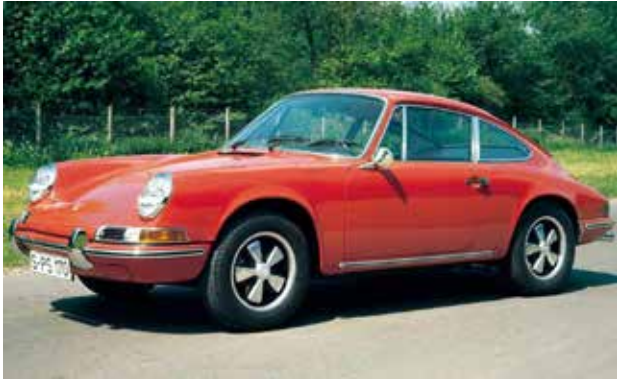

Batterie

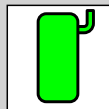

Kraftstofftank

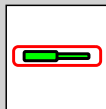

Gasdruck-
dämpfer



Porsche AG, 911 Urmodell, Targa, alle Derivate

PORSCHE MJ 1965 bis MJ 1973

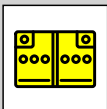
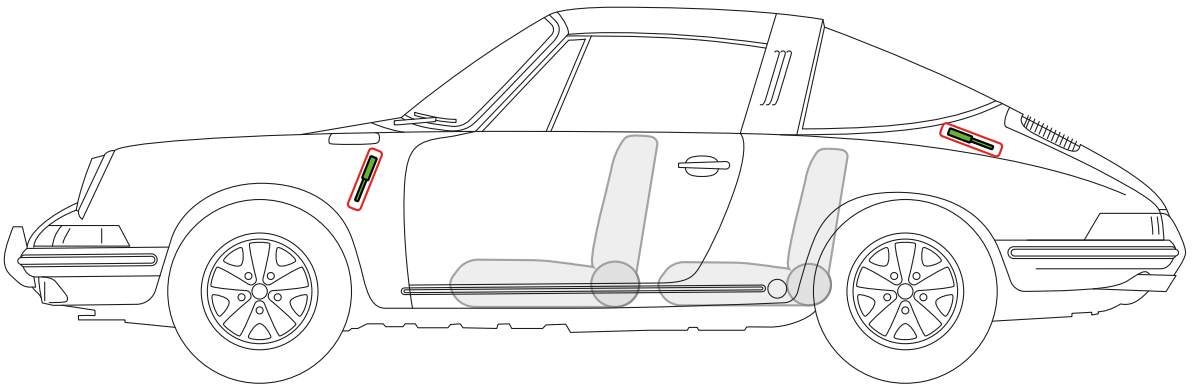
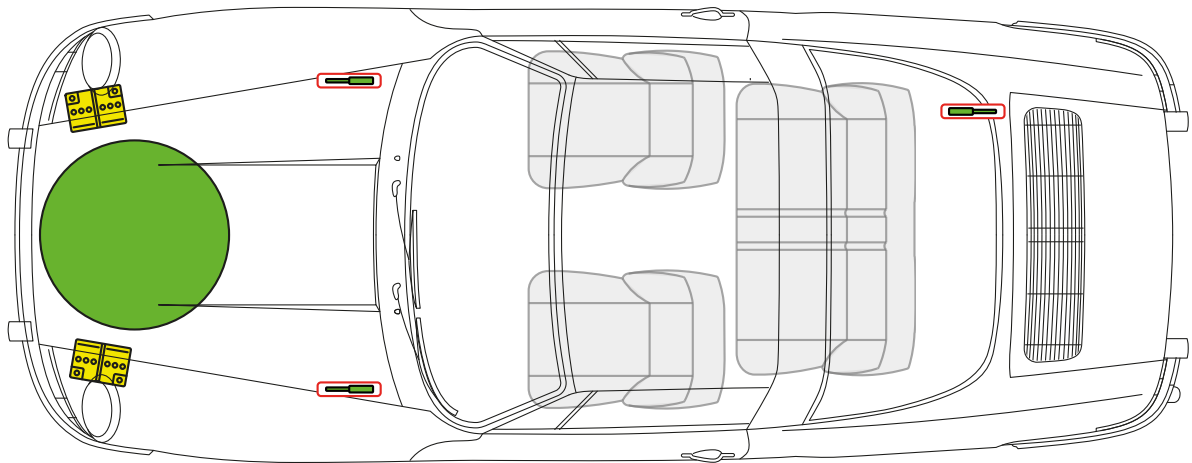

Batterie

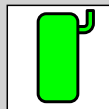

Kraftstofftank

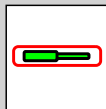

Gasdruck-
dämpfer



Porsche AG, 911 G-Modell, Coupé, alle Derivate

PORSCHE MJ 1974 bis MJ 1989

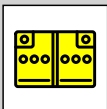
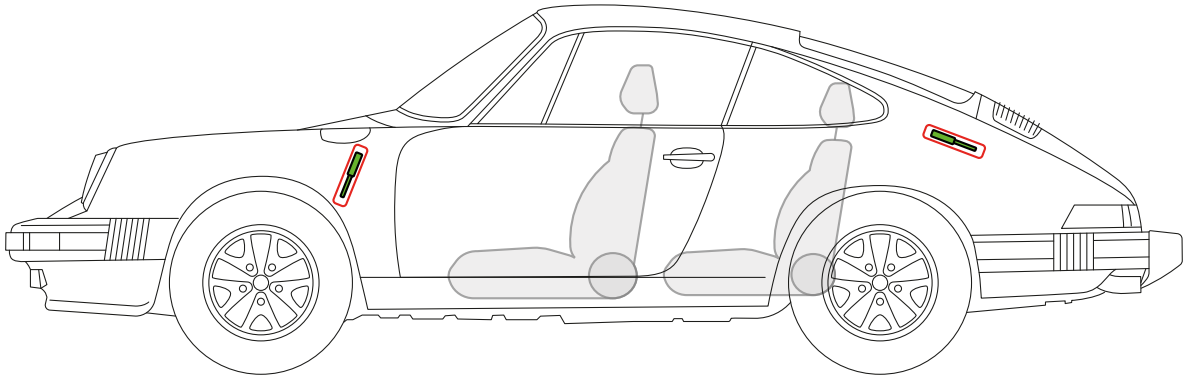
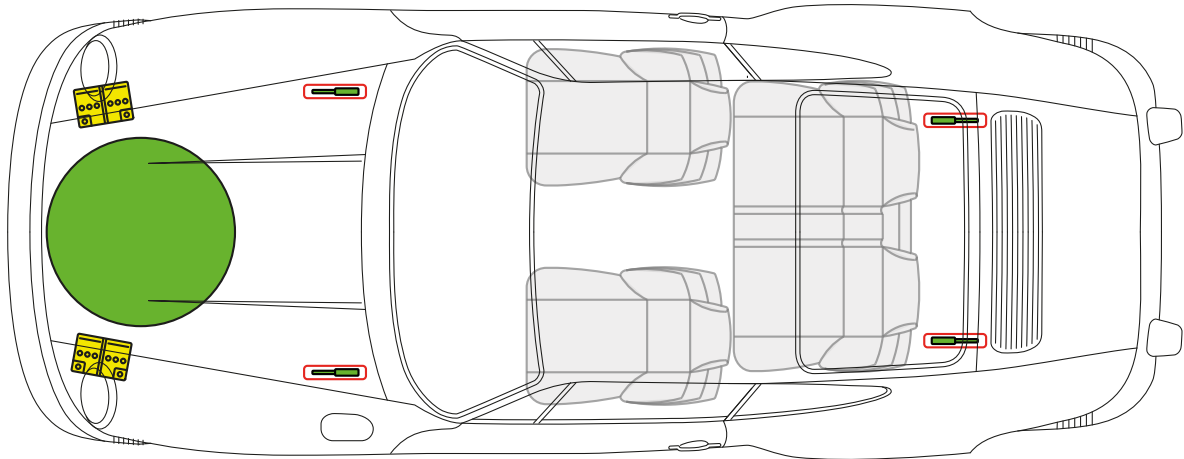
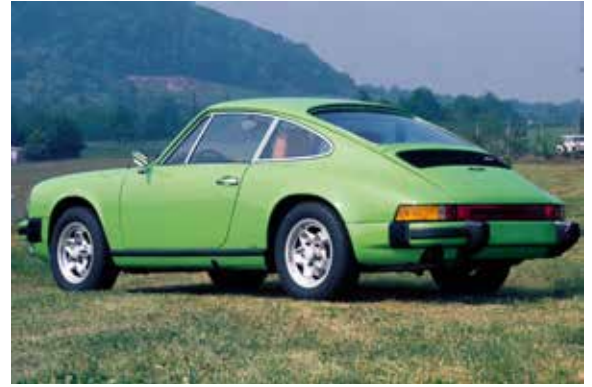

Batterie

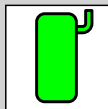

Kraftstofftank

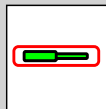

Gasdruck-
dämpfer



Porsche AG, 911 G-Modell, Targa, alle Derivate

PORSCHE MJ 1974 bis MJ 1989

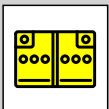
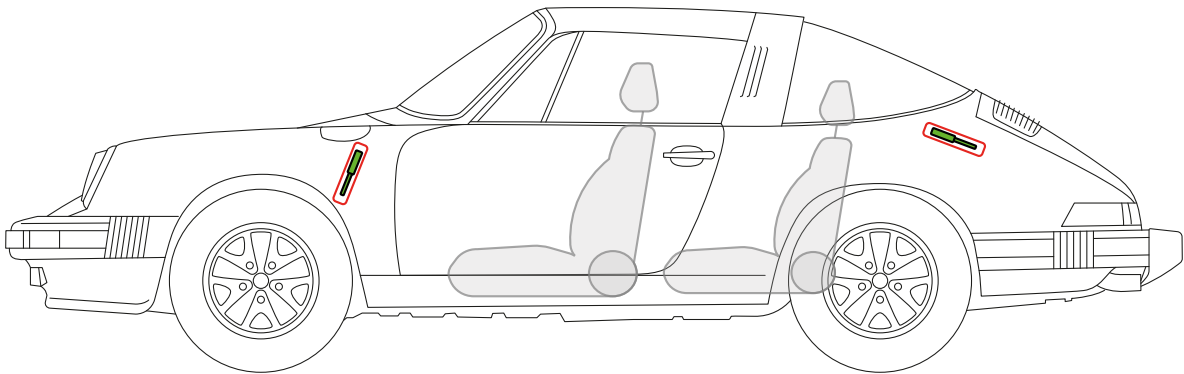
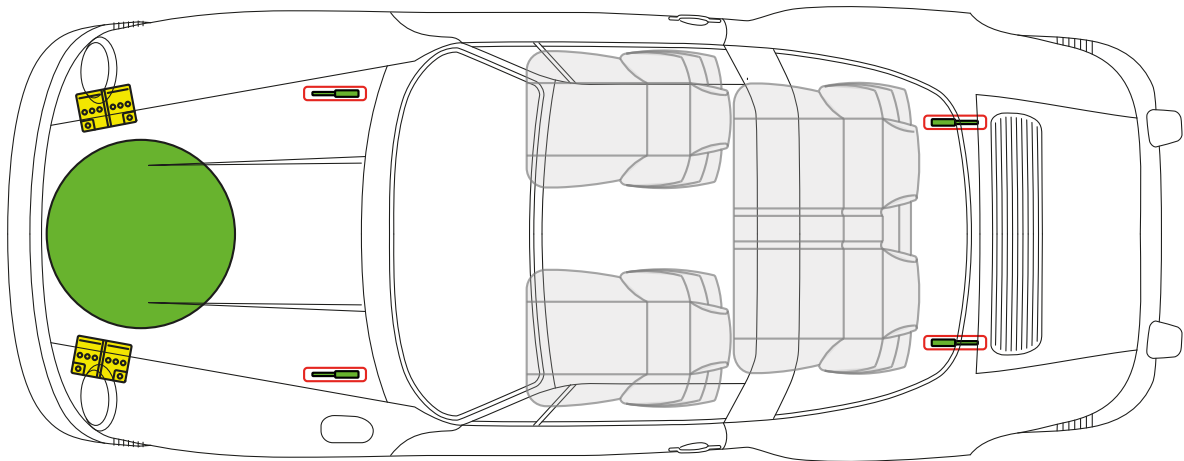

Batterie

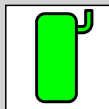

Kraftstofftank

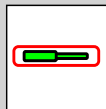

Gasdruck-
dämpfer



Porsche AG, 911 G-Modell, Cabriolet, alle Derivate

PORSCHE MJ 1983 bis MJ 1989

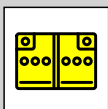
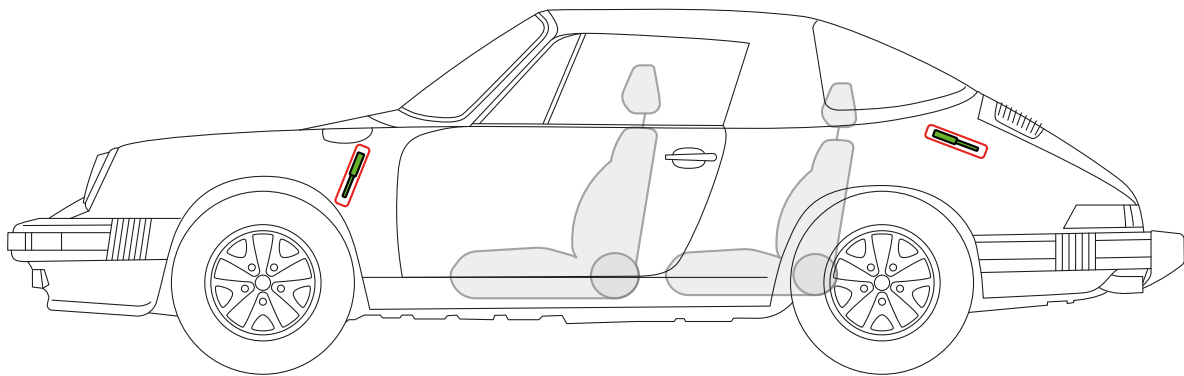
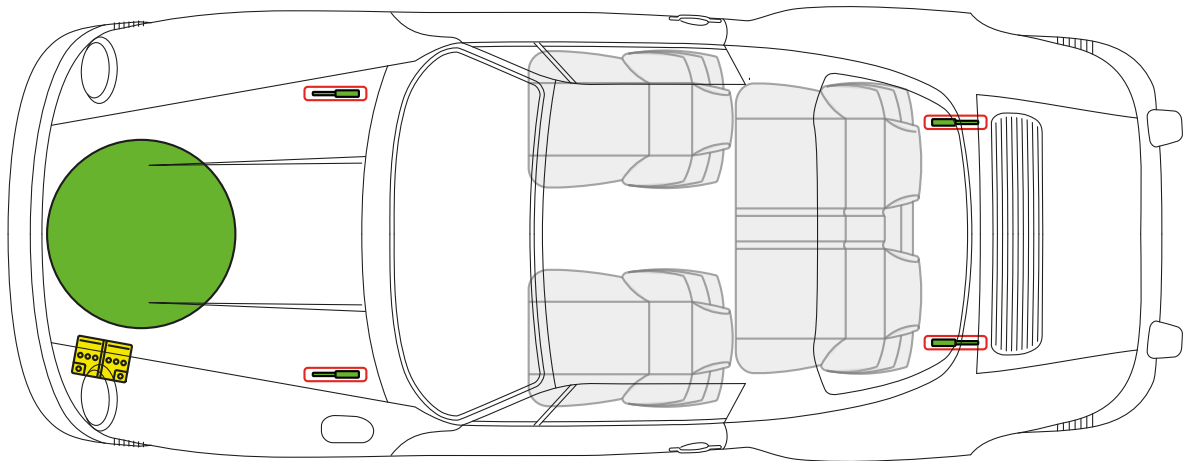

Batterie

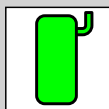

Kraftstofftank

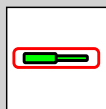

Gasdruck-
dämpfer



Porsche AG, 911 G-Modell Turbo (930), Coupé, alle Derivate

PORSCHE MJ 1974 bis MJ 1989

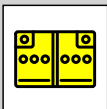
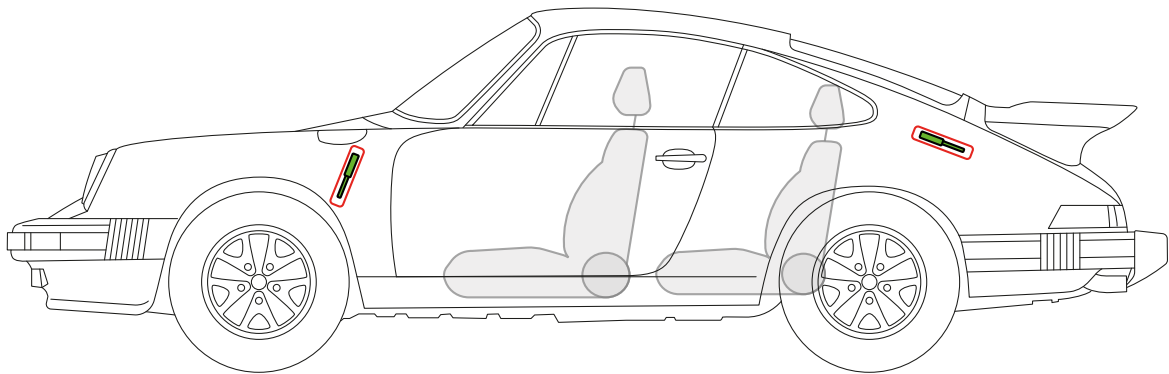
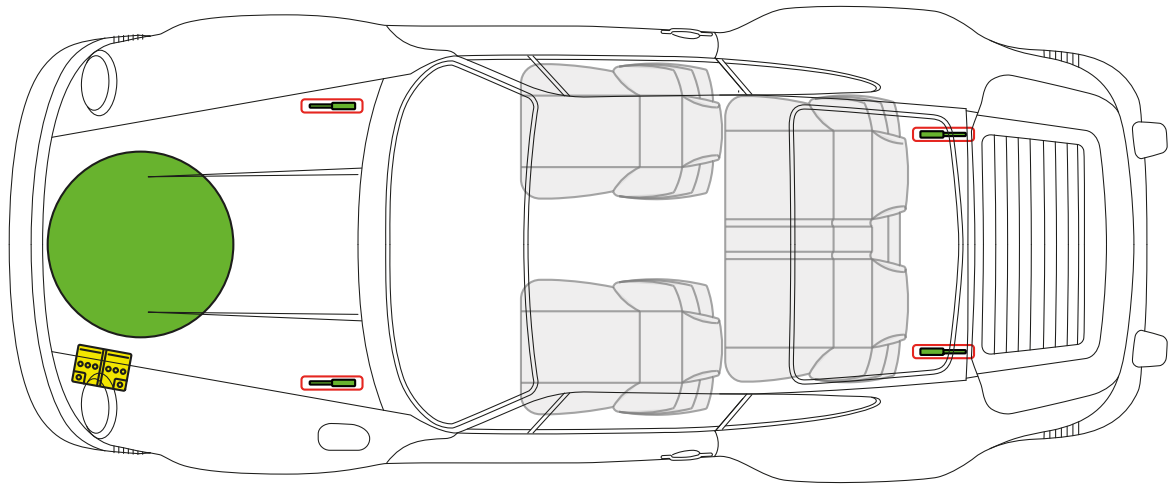

Batterie

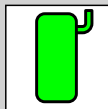

Kraftstofftank

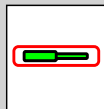

Gasdruck-
dämpfer



Porsche AG, 911 G-Modell Turbo (930), Targa, alle Derivate

PORSCHE MJ 1986 bis MJ 1989

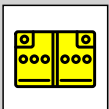
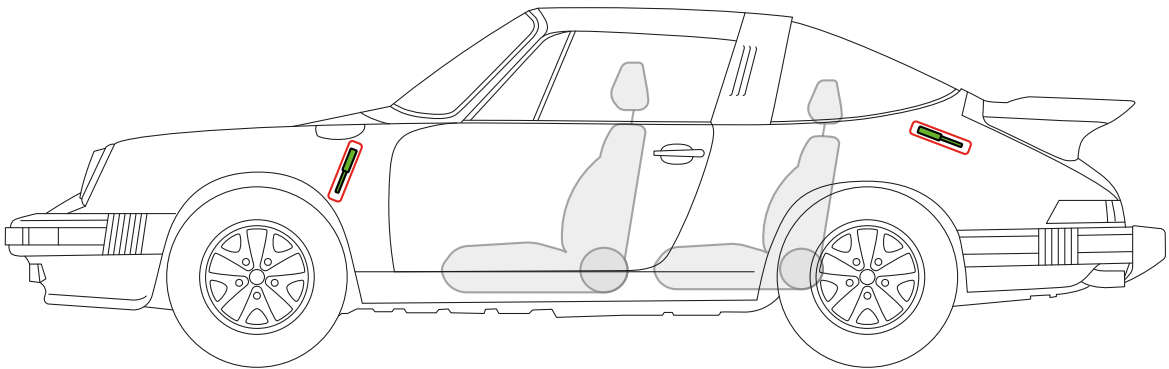
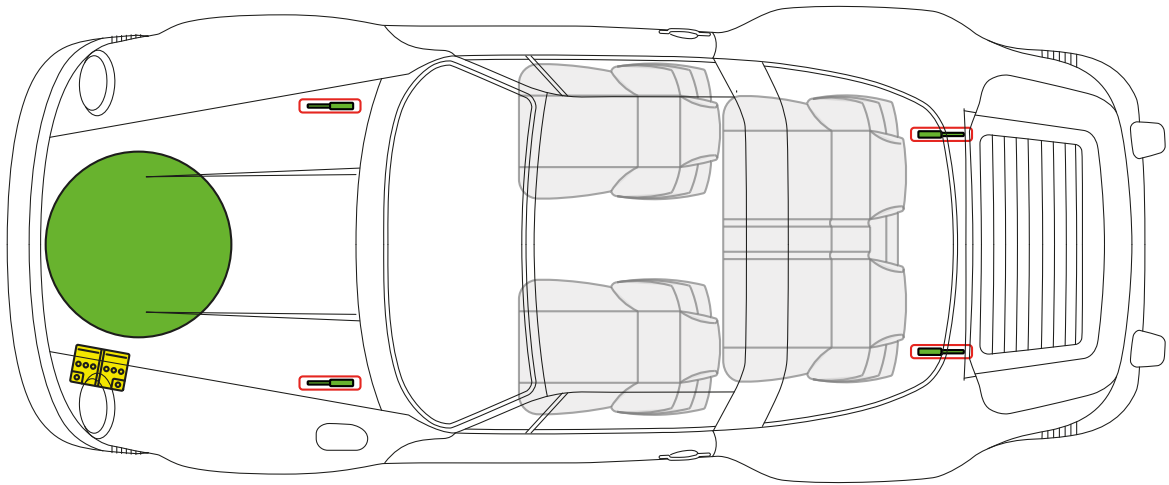
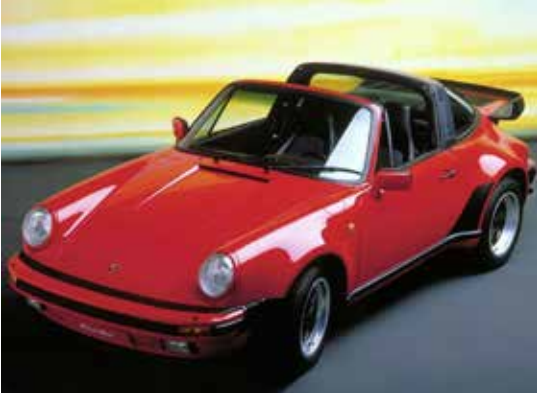

Batterie

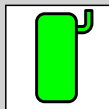

Kraftstofftank

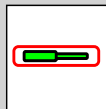

Gasdruck-
dämpfer



Porsche AG, 911 G-Modell Turbo (930), Cabriolet, alle Derivate

PORSCHE MJ 1986 bis MJ 1989

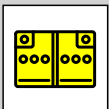
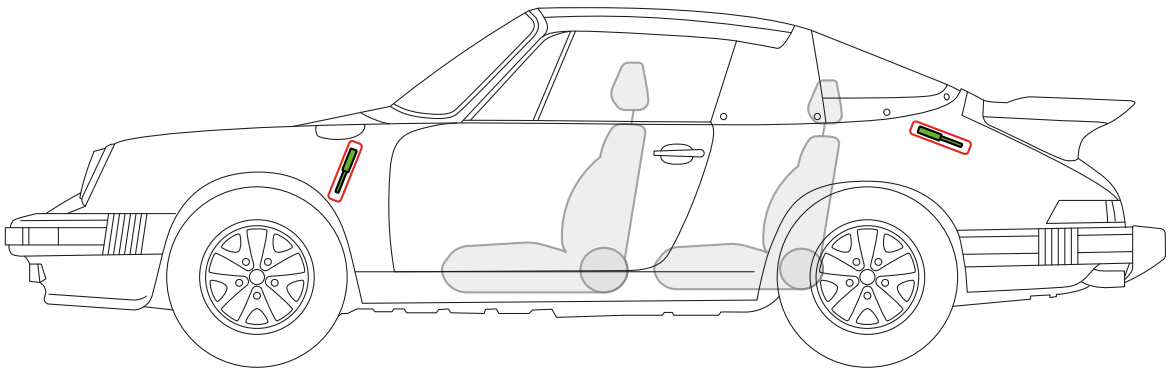
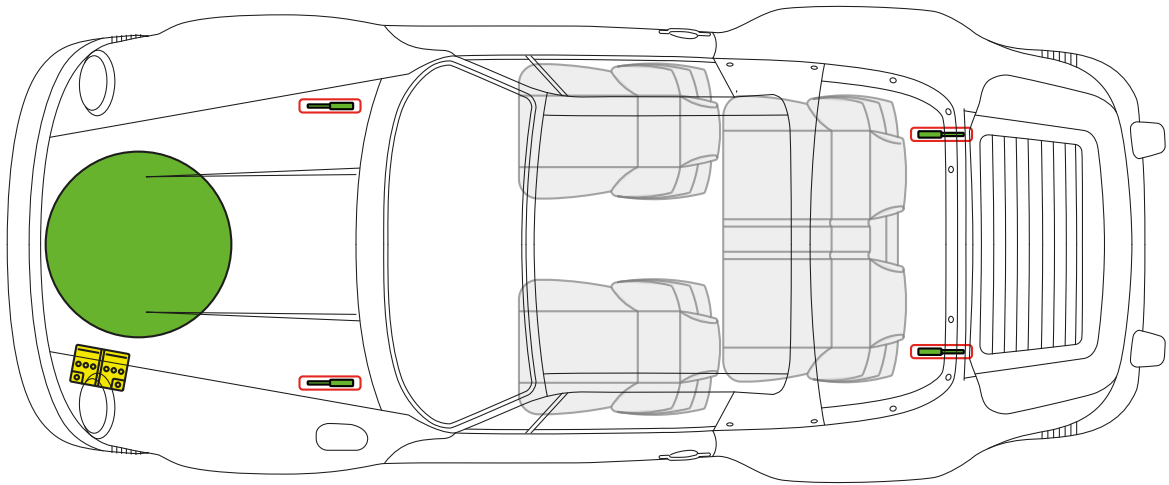

Batterie

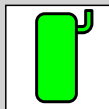

Kraftstofftank

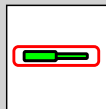

Gasdruck-
dämpfer



Porsche AG, 912, 912 E, Coupé, alle Derivate

PORSCHE MJ 1965 bis MJ 1969 und MJ 1976 (912 E)

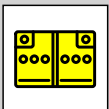
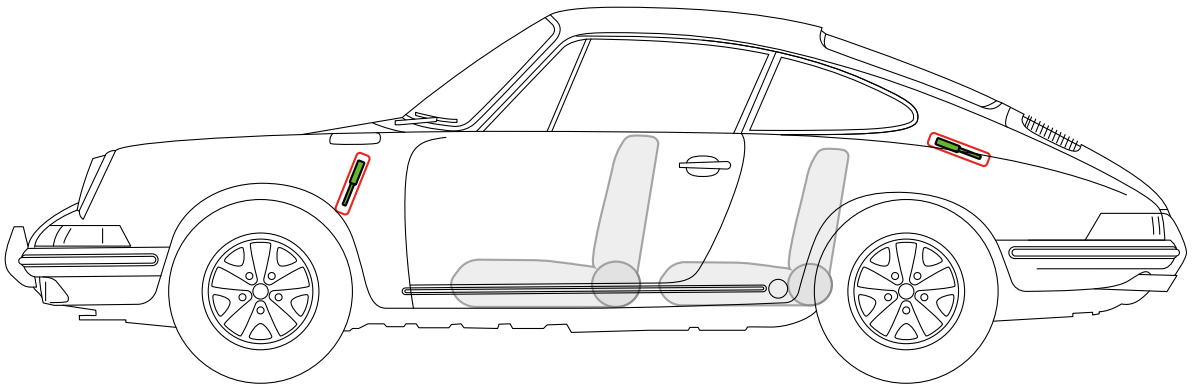
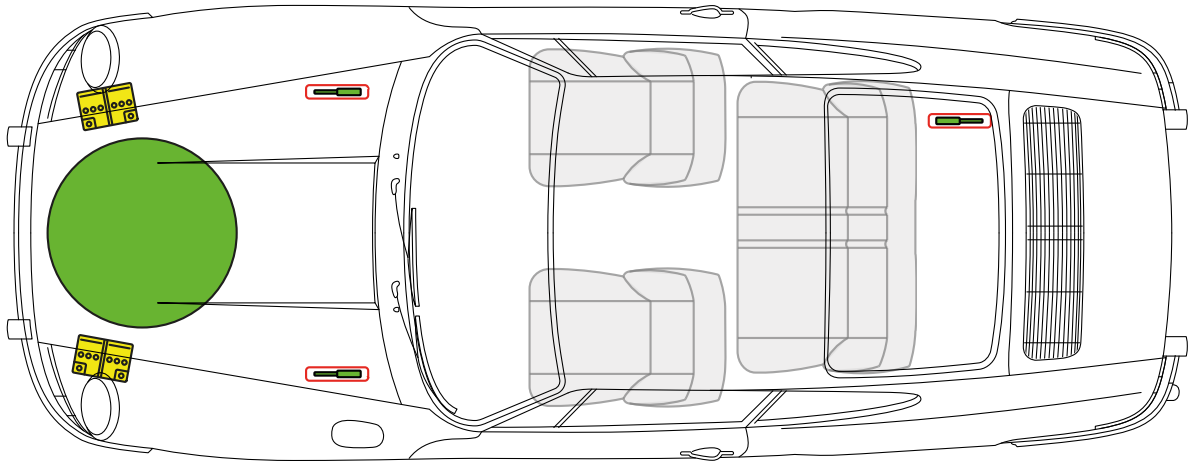

Batterie

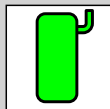

Kraftstofftank

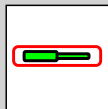

Gasdruck-
dämpfer



Porsche AG, 912, Targa, alle Derivate

PORSCHE MJ 1965 bis MJ 1969

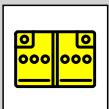
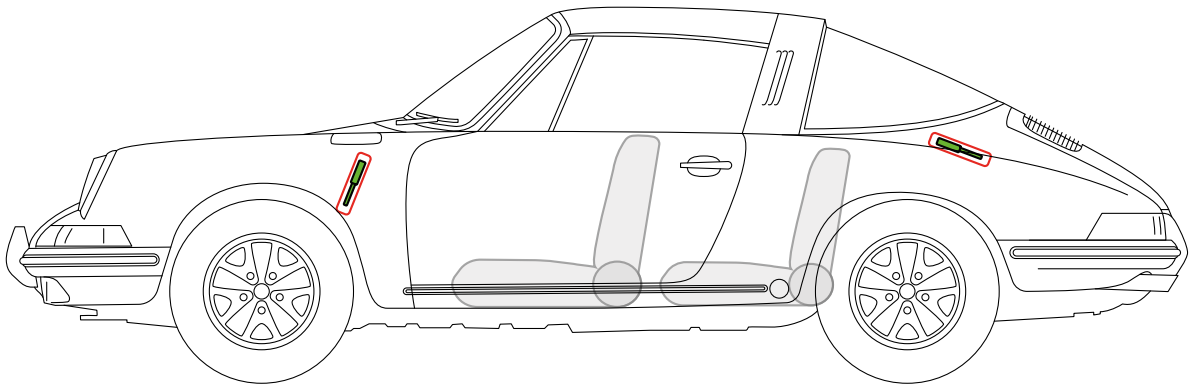
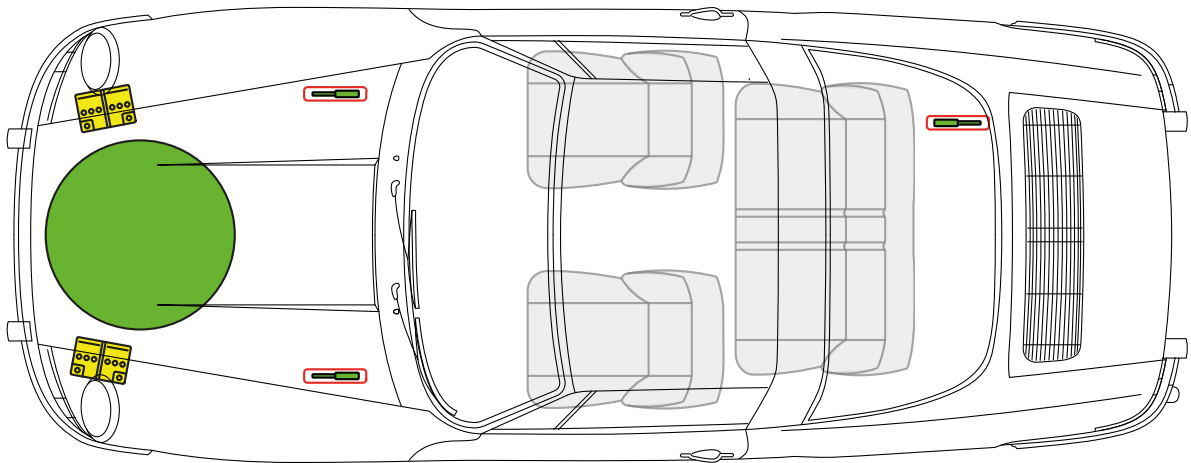

Batterie

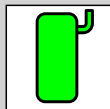

Kraftstofftank

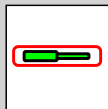

Gasdruck-
dämpfer



**Porsche AG, 914, Coupe,
alle Derivate**

PORSCHE MJ 1970 bis MJ 1976

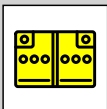
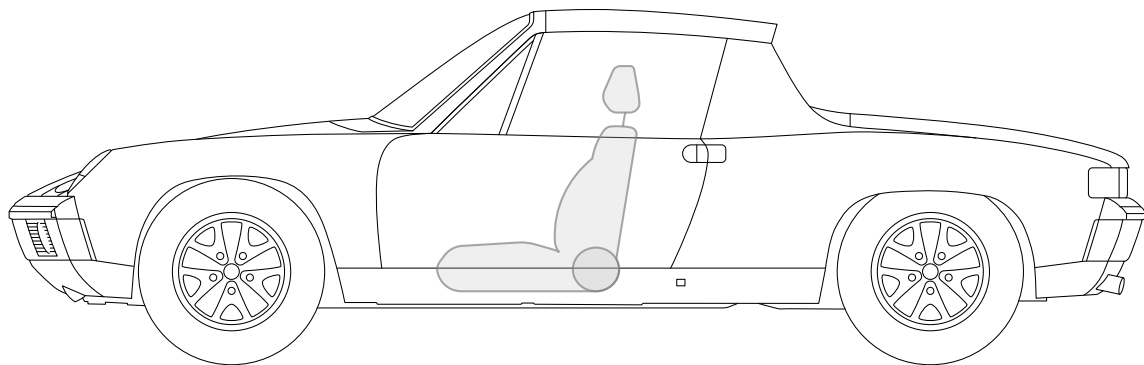
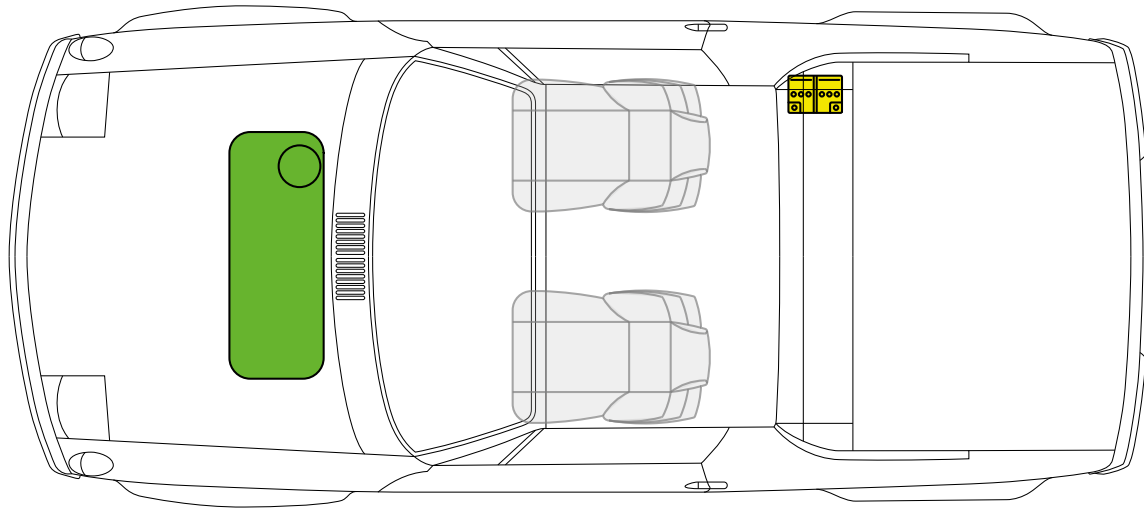

Batterie

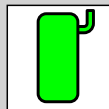

Kraftstofftank



Porsche AG, 924, Coupé, alle Derivate

PORSCHE MJ 1976 bis MJ 1988

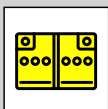
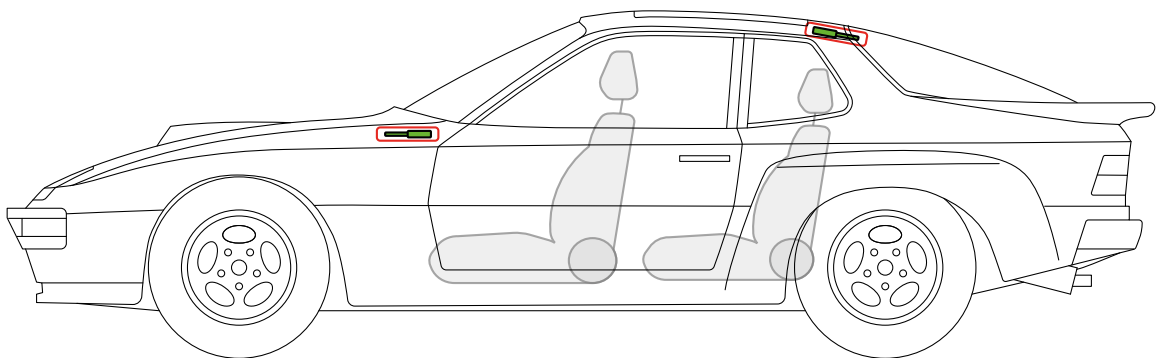
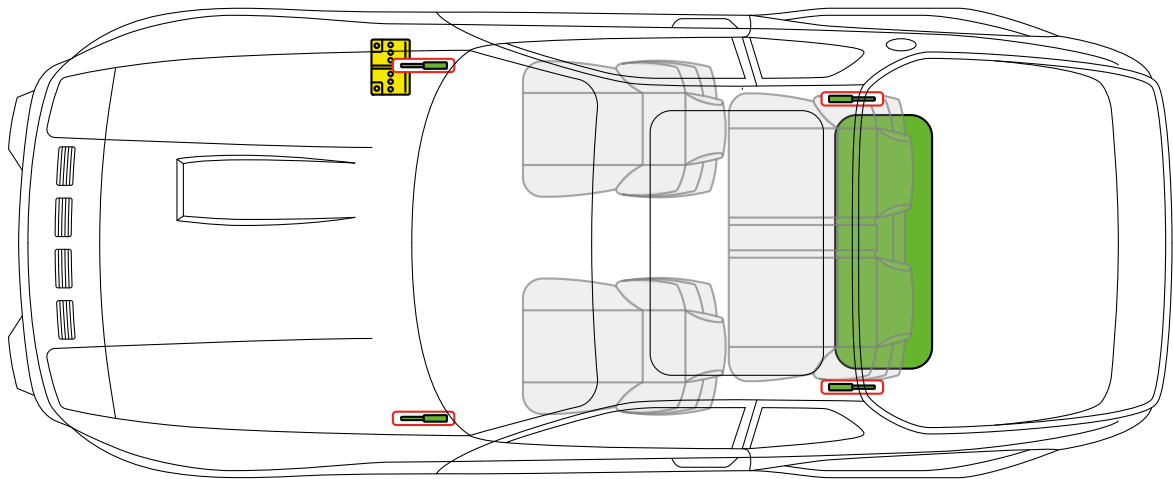

Batterie

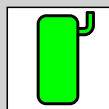

Kraftstofftank

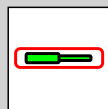

Gasdruck-
dämpfer



Porsche AG, 928, Coupé, alle Derivate

PORSCHE MJ 1977 bis MJ 1995

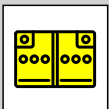
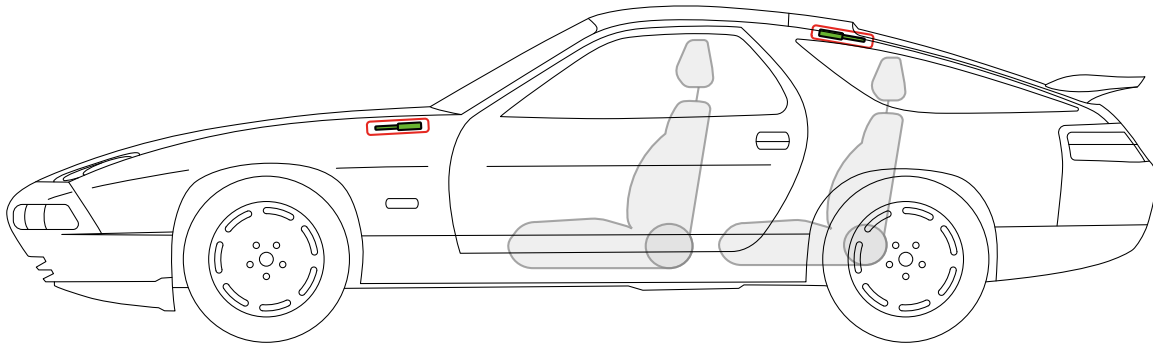
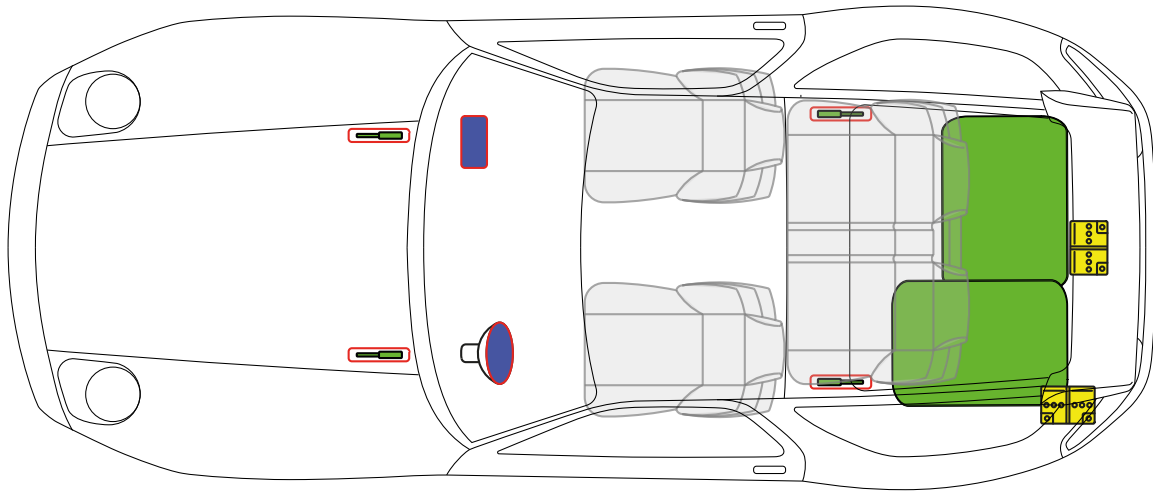

Batterie

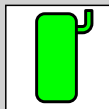

Kraftstofftank

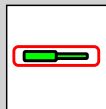

Gasdruck-
dämpfer

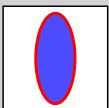

Airbag



Porsche AG, 944 Coupé, Targa, alle Derivate

PORSCHE MJ 1982 bis MJ 1991

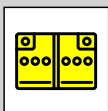
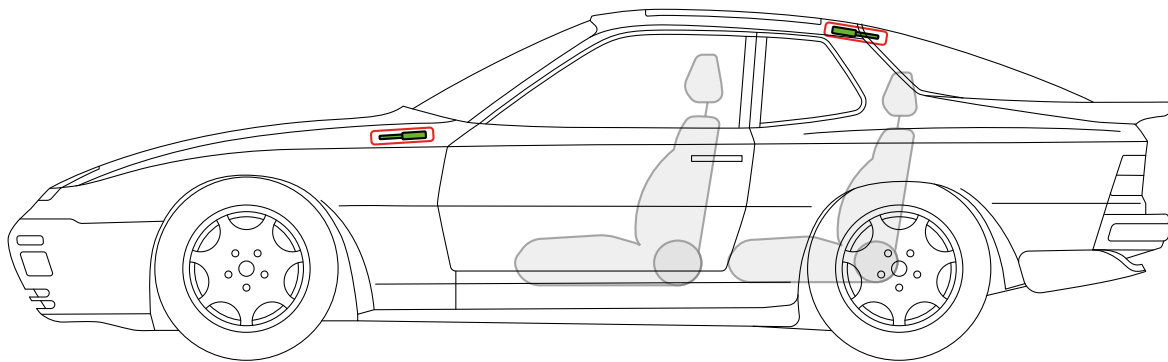
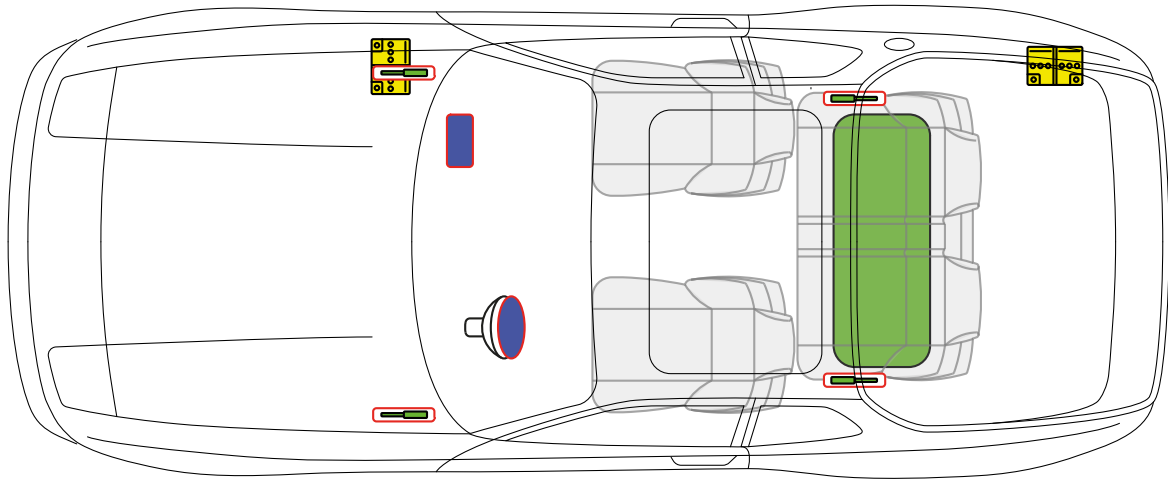
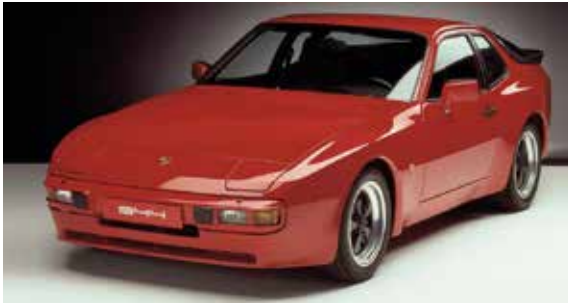

Batterie

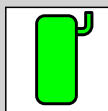

Kraftstofftank

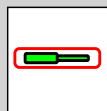

Gasdruck-
dämpfer

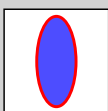

Airbag



Porsche AG, 944, Cabriolet, alle Derivate

PORSCHE MJ 1989 bis MJ 1991

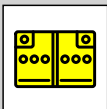
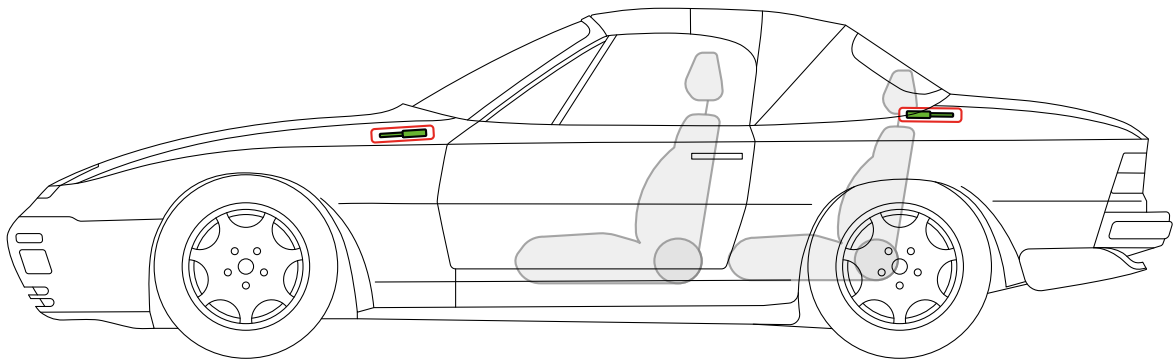
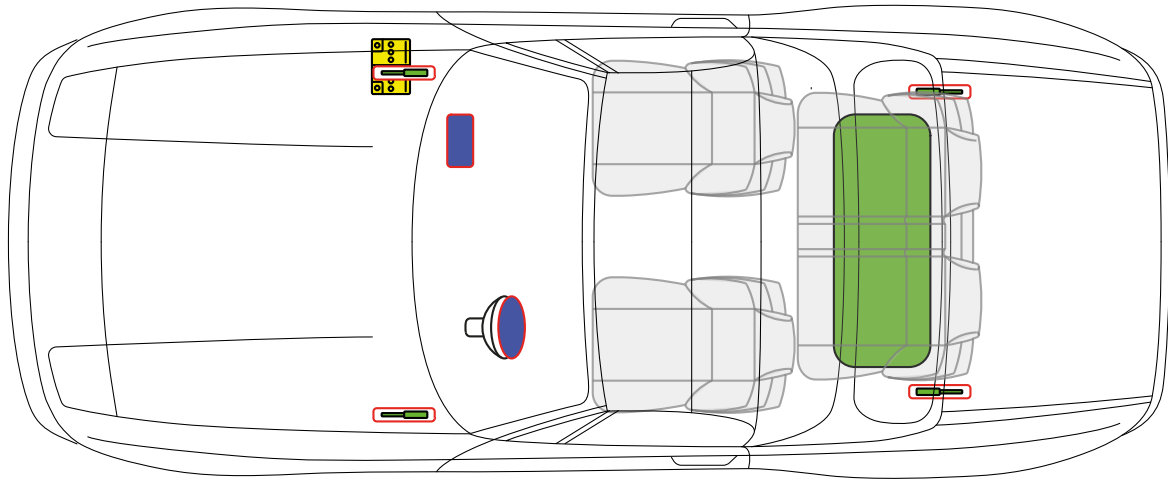

Batterie

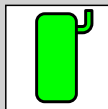

Kraftstofftank

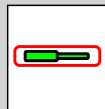

Gasdruck-
dämpfer

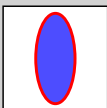

Airbag



**Porsche AG, 959, Coupé,
alle Derivate**

PORSCHE MJ 1986 bis MJ 1988

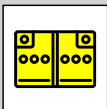
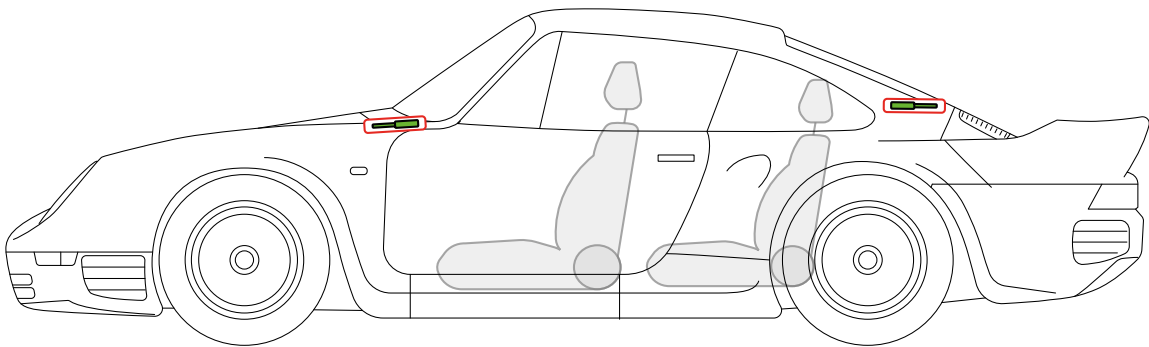
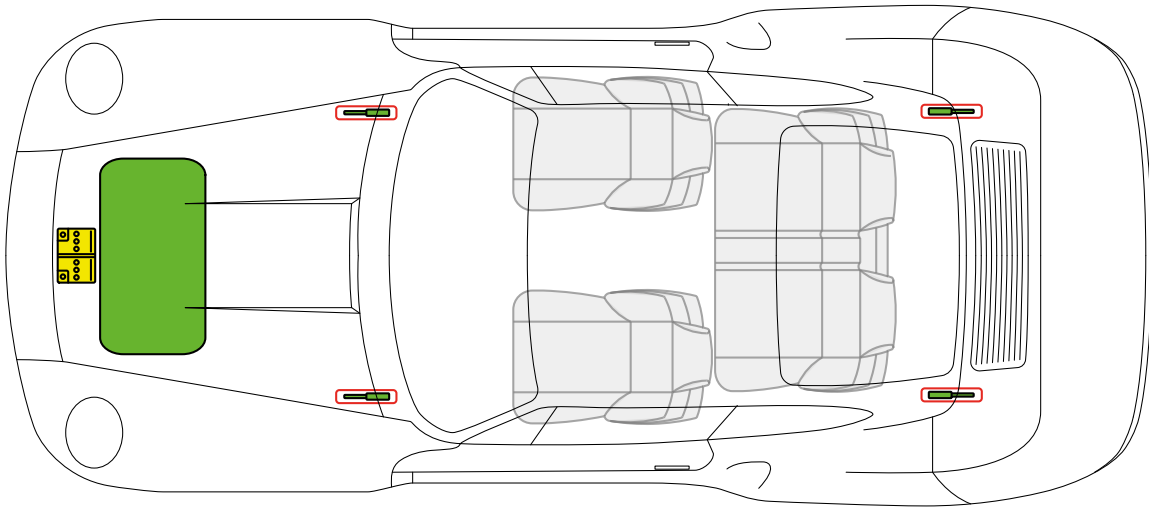

Batterie

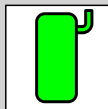

Kraftstofftank

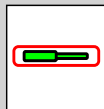

Gasdruck-
dämpfer



Porsche AG, 964, Coupé, alle Derivate

PORSCHE MJ 1989 bis MJ 1994

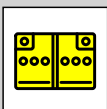
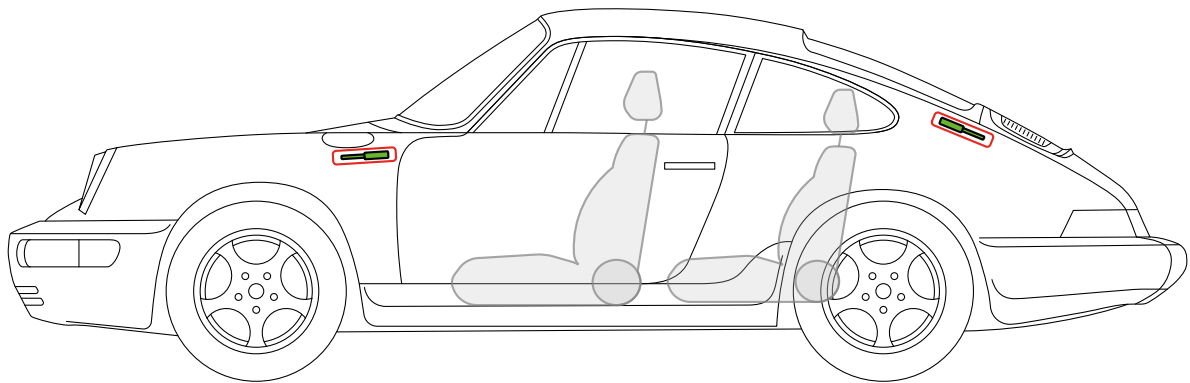
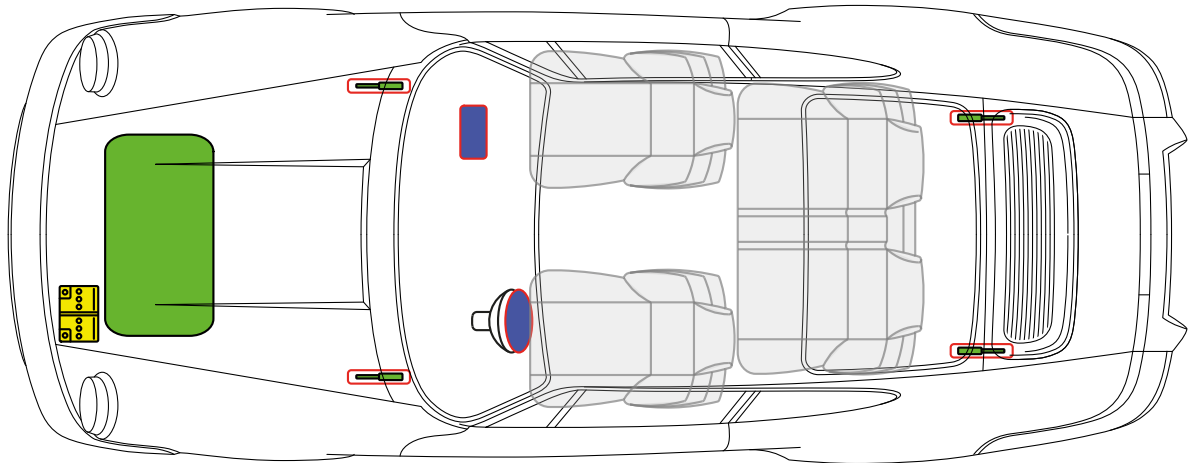
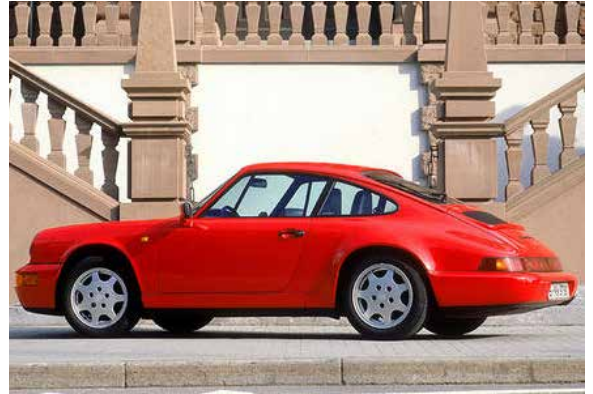
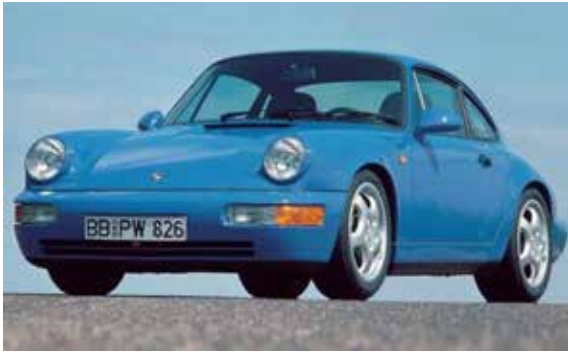

Batterie

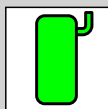

Kraftstofftank

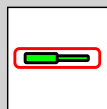

Gasdruck-
dämpfer

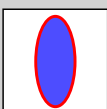

Airbag



Porsche AG, 964, Targa, alle Derivate

PORSCHE MJ 1990 bis MJ 1994

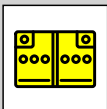
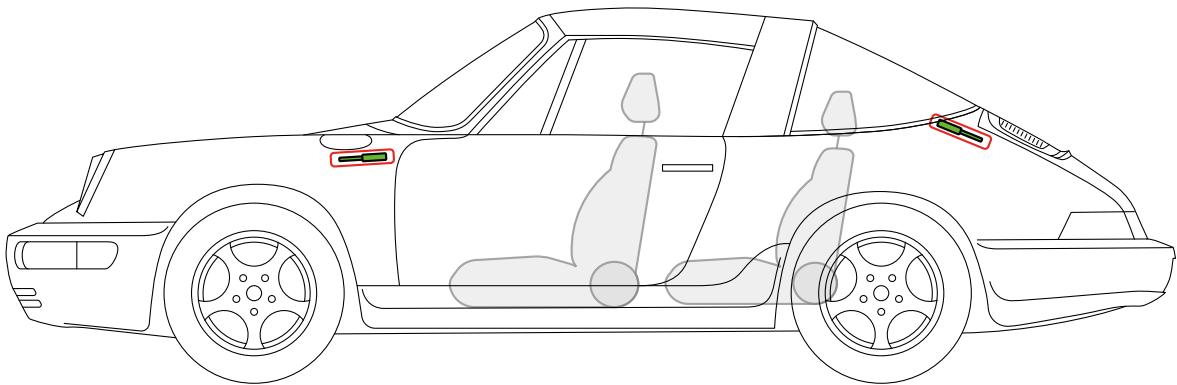
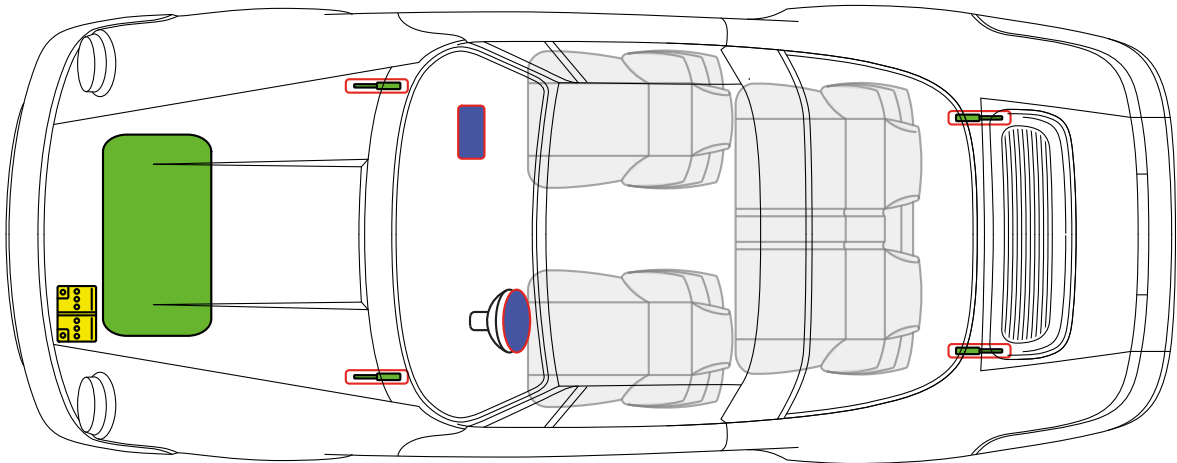

Batterie

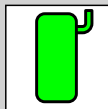

Kraftstofftank

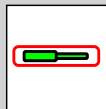

Gasdruck-
dämpfer

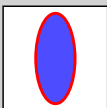

Airbag



Porsche AG, 964, Cabriolet, Speedster, alle Derivate

PORSCHE MJ 1990 bis MJ 1994

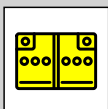
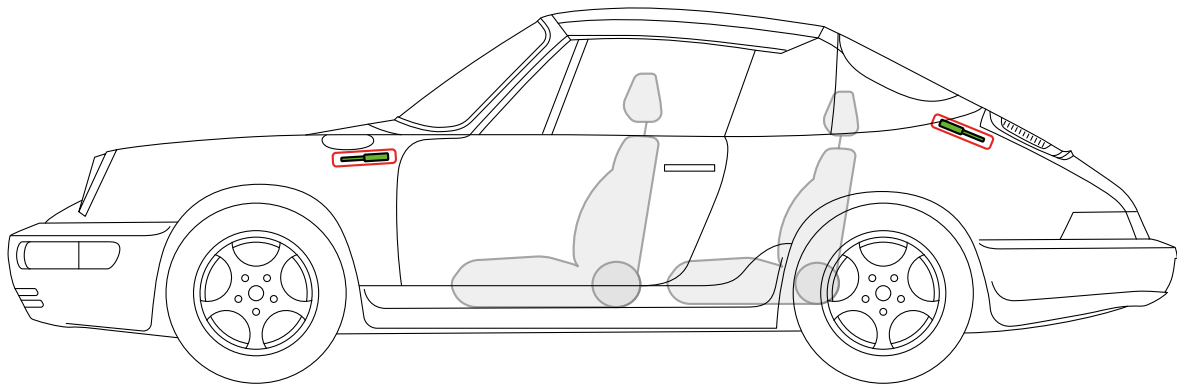
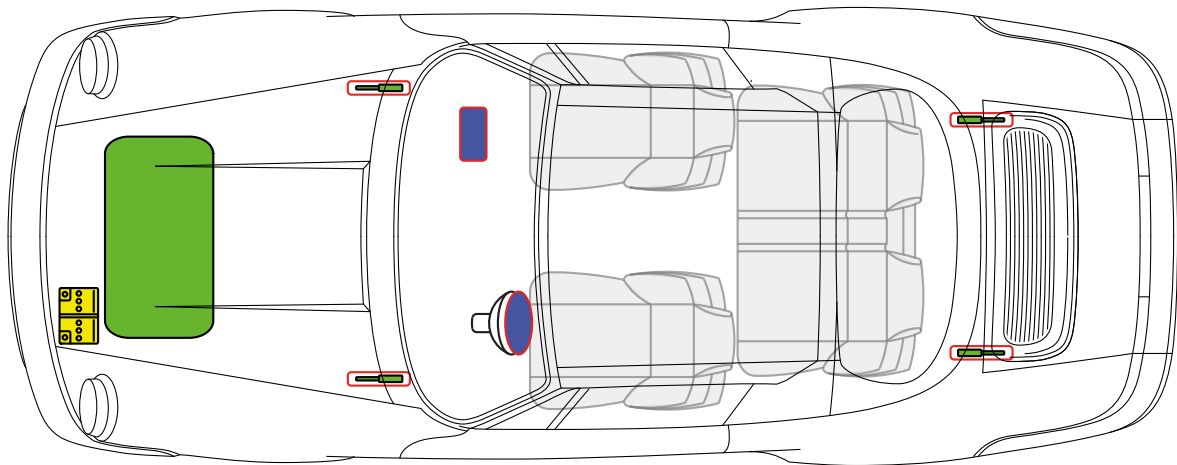

Batterie

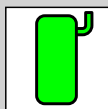

Kraftstofftank

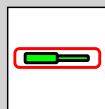

Gasdruck-
dämpfer

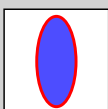

Airbag



Porsche AG, 964, Coupé, Turbo, alle Derivate

PORSCHE MJ 1990 bis MJ 1994

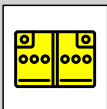
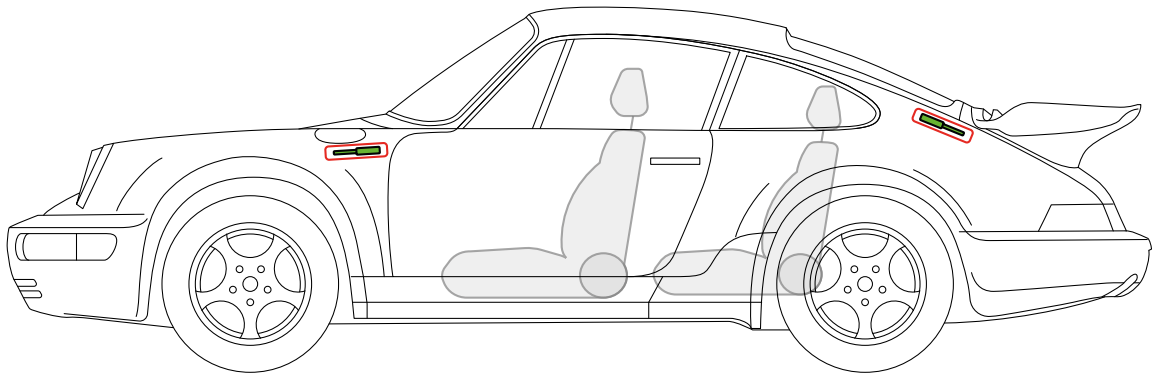
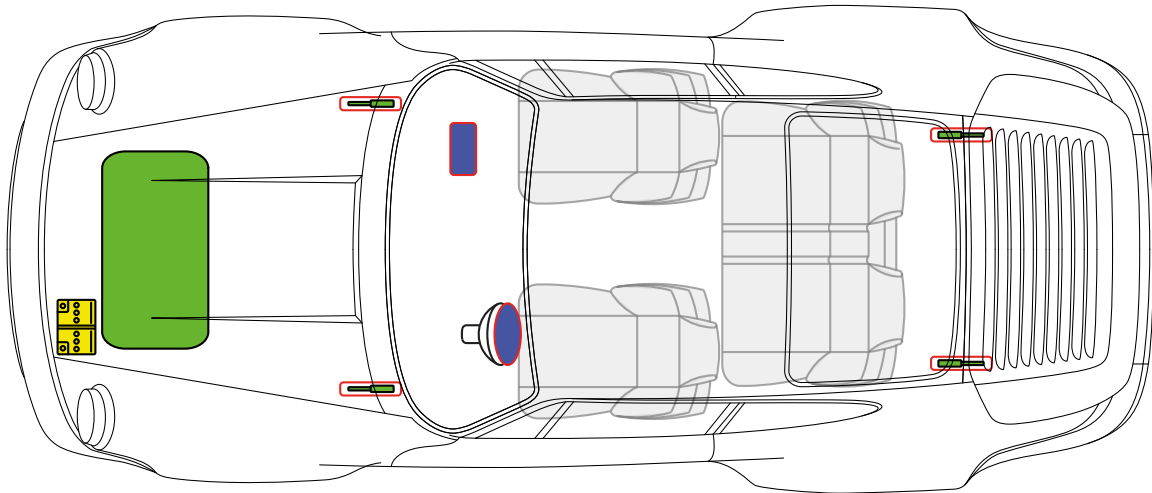
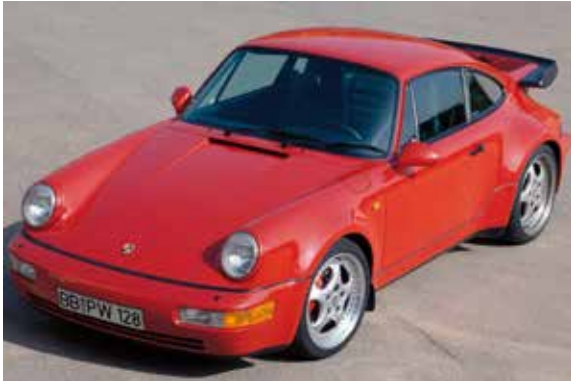

Batterie

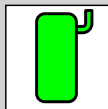

Kraftstofftank

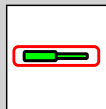

Gasdruck-
dämpfer

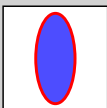

Airbag



Porsche AG, 968, Coupé, alle Derivate

PORSCHE MJ 1991 bis MJ 1995

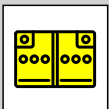
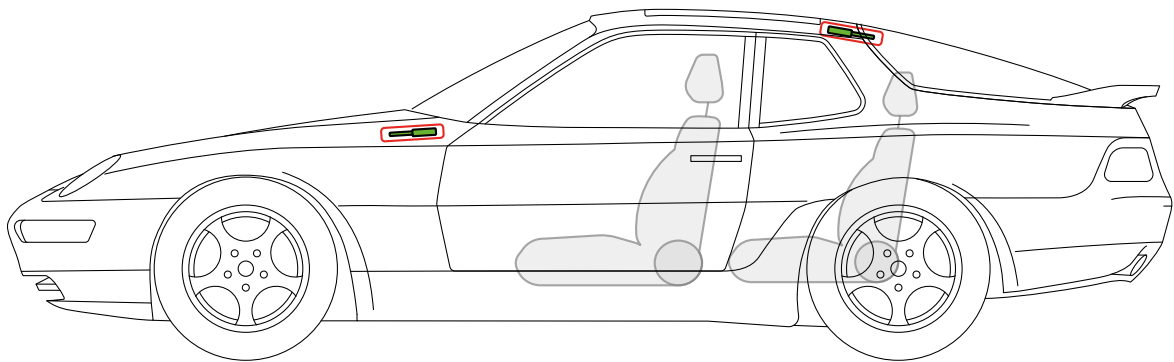
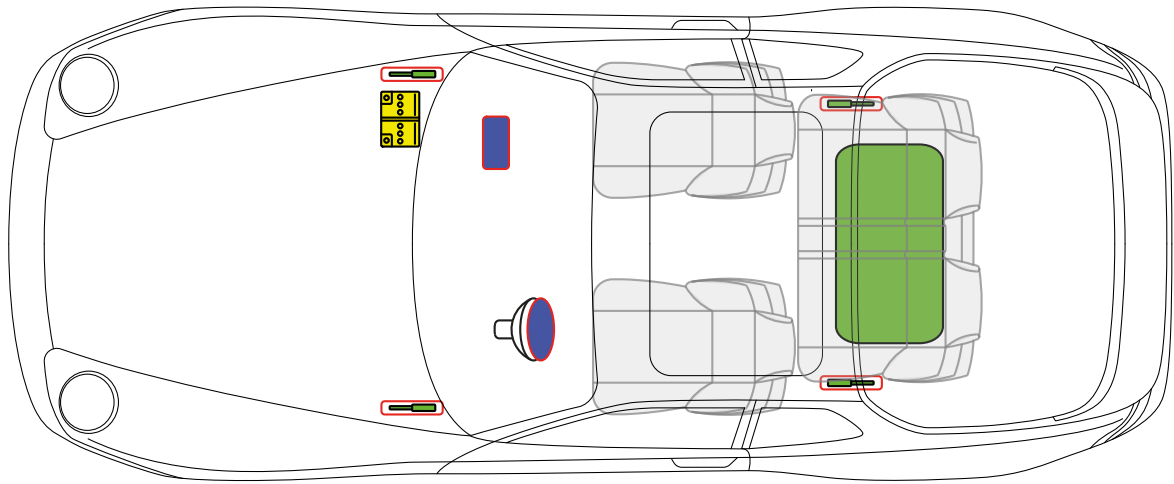

Batterie

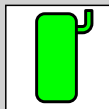

Kraftstofftank

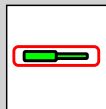

Gasdruck-
dämpfer

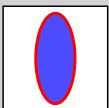

Airbag



Porsche AG, 968, Cabriolet, alle Derivate

PORSCHE MJ 1991 bis MJ 1995

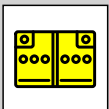
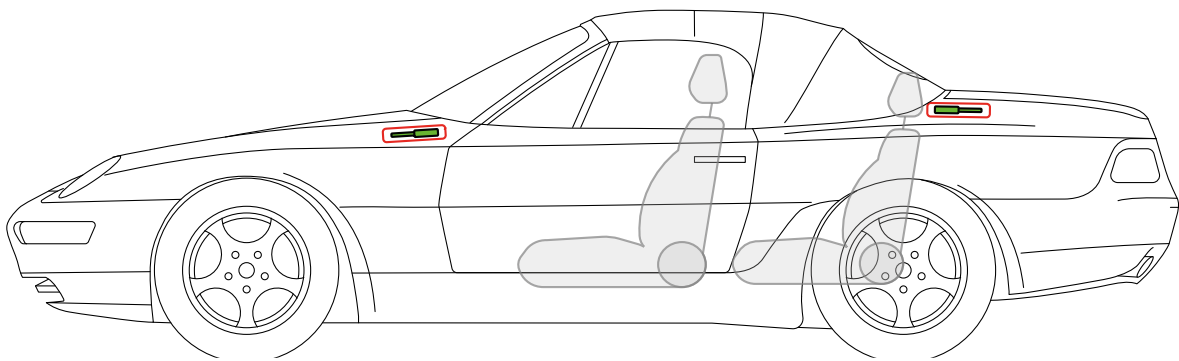
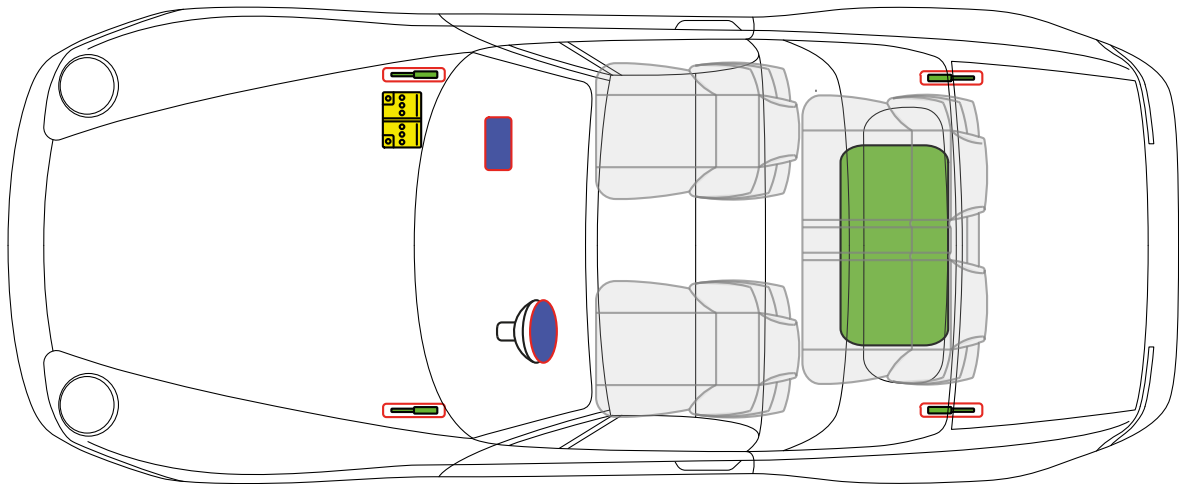

Batterie

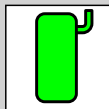

Kraftstofftank

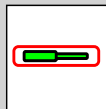

Gasdruck-
dämpfer

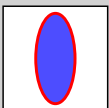

Airbag



Porsche AG, 993, Coupé, alle Derivate

PORSCHE MJ 1994 bis MJ 1998

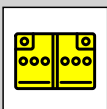
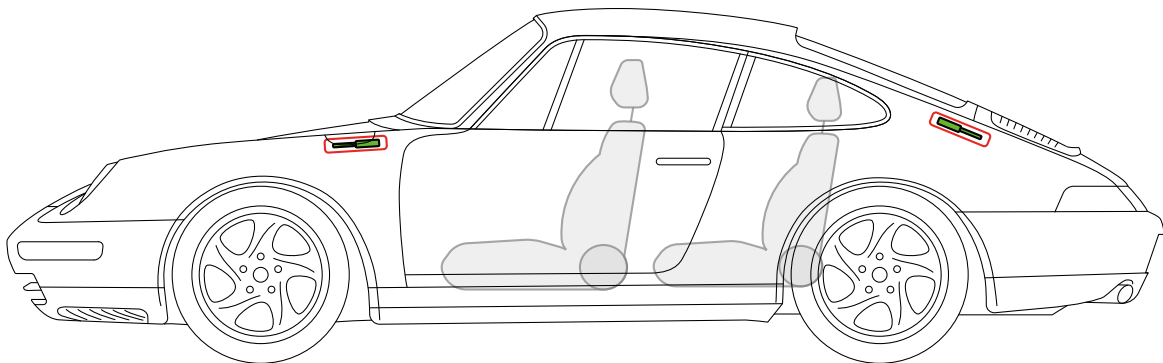
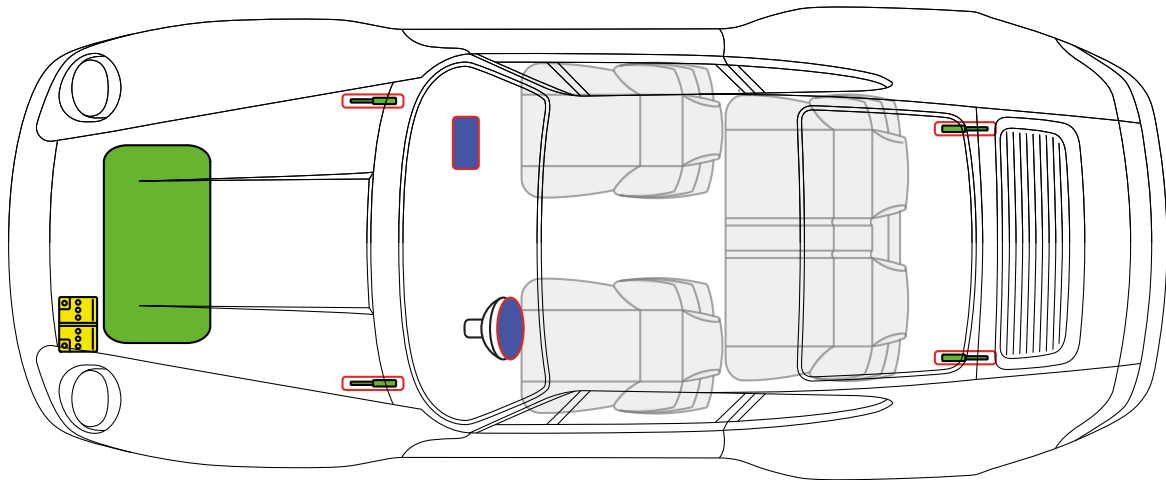

Batterie

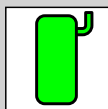

Kraftstofftank

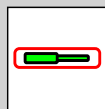

Gasdruck-
dämpfer

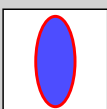

Airbag



Porsche AG, 993, Targa, alle Derivate

PORSCHE MJ 1994 bis MJ 1998

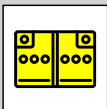
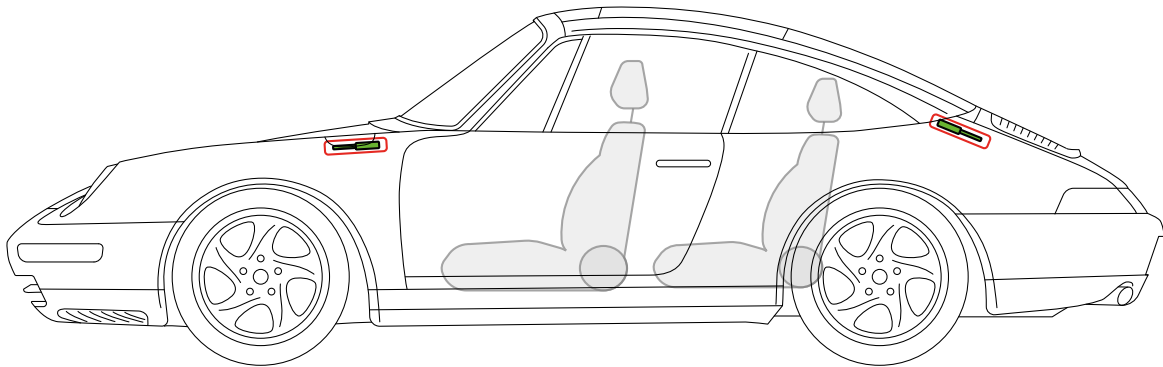
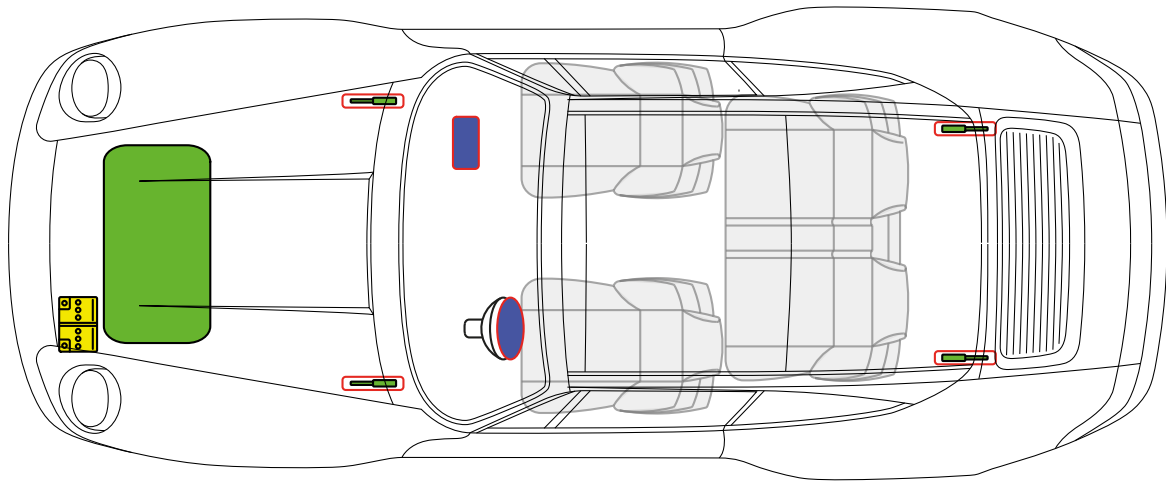

Batterie

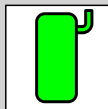

Kraftstofftank

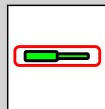

Gasdruck-
dämpfer

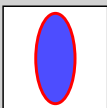

Airbag



Porsche AG, 993, Cabriolet, alle Derivate

PORSCHE MJ 1994 bis MJ 1998

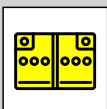
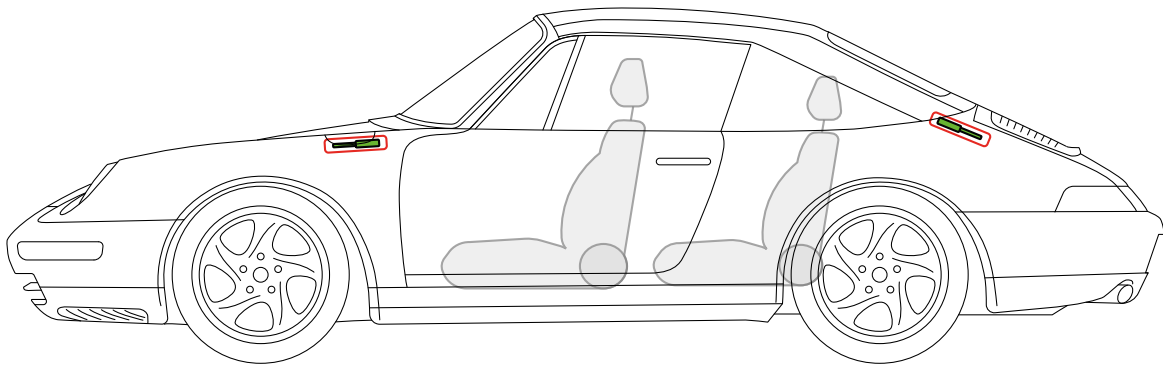
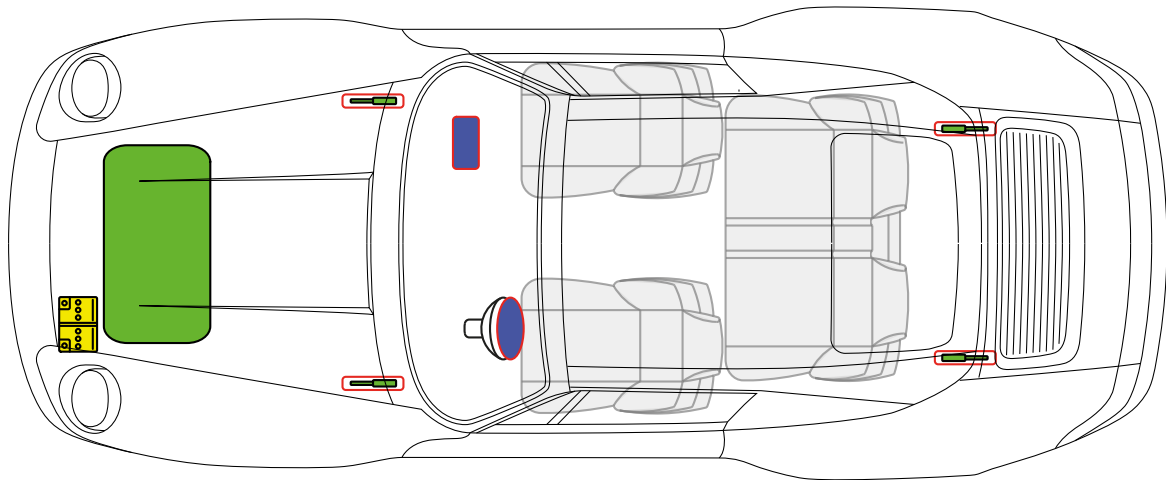

Batterie

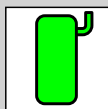

Kraftstofftank

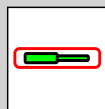

Gasdruck-
dämpfer

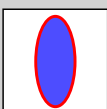

Airbag



Porsche AG, 986, Boxster, Cabriolet, alle Derivate

PORSCHE MJ 1997 bis MJ 2004

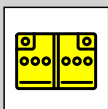
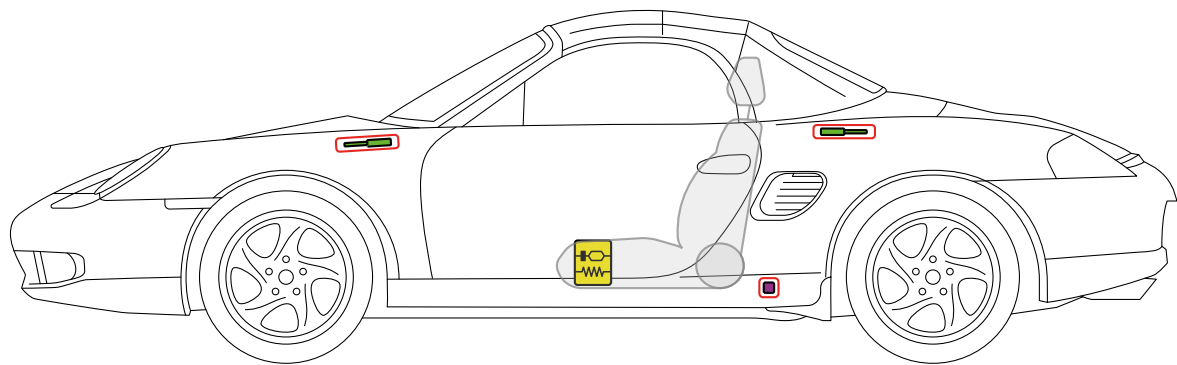
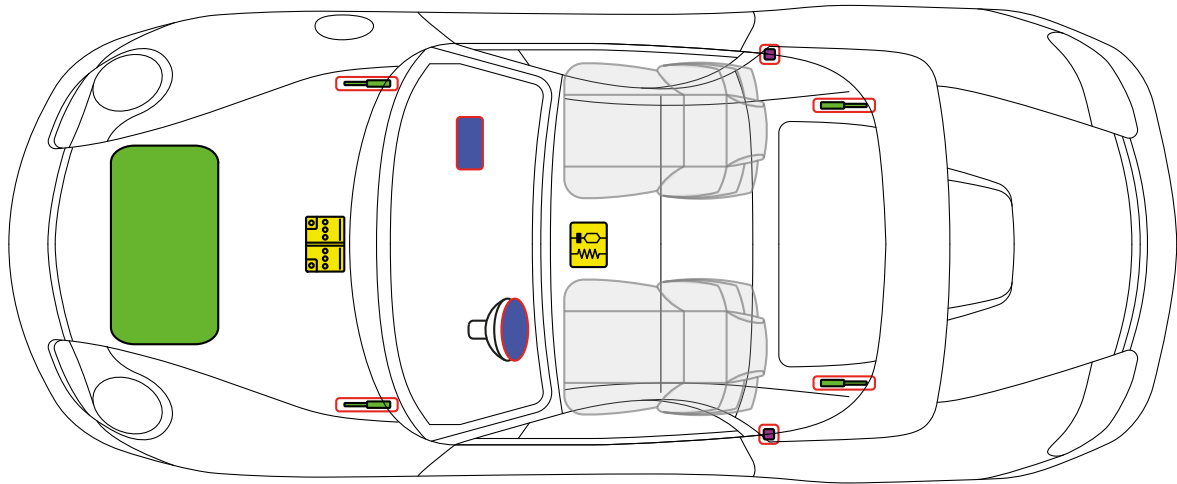

Batterie

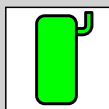

Kraftstofftank

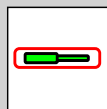

Gasdruck-
dämpfer



SRS
Steuergerät

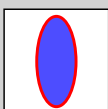

Airbag



Gurtstraffer



Porsche AG, 996, Coupé, alle Derivate

PORSCHE MJ 1998 bis MJ 2005

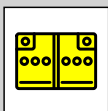
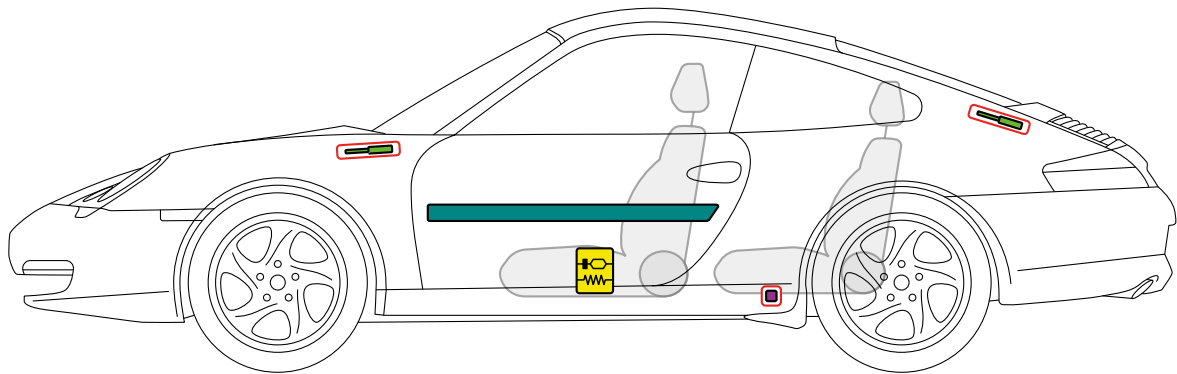
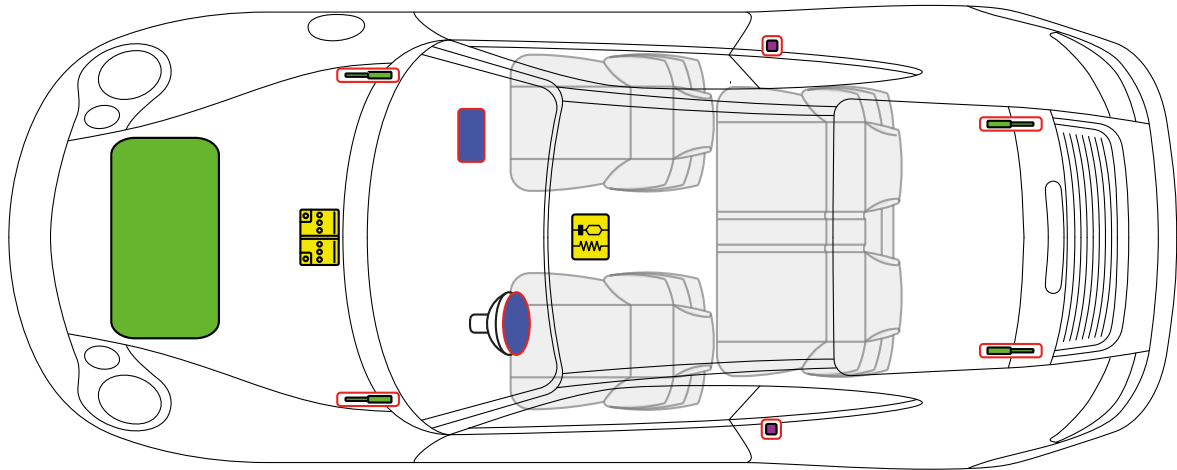
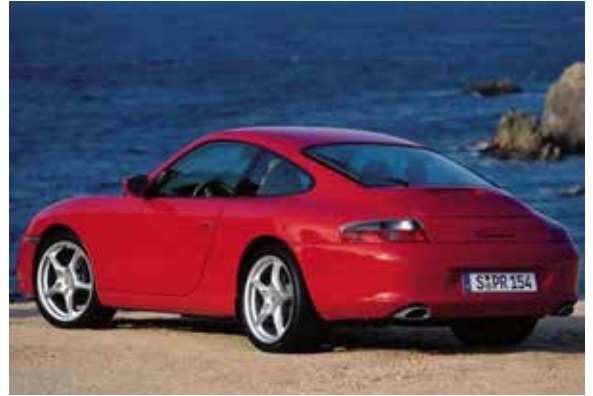

Batterie

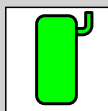

Kraftstofftank

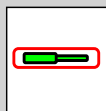

Gasdruck-
dämpfer



SRS
Steuergerät

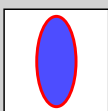

Airbag



Gurtstraffer

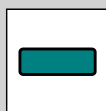

Karosserie-
verstärkung



Porsche AG, 996, Targa, alle Derivate

PORSCHE MJ 1998 bis MJ 2005

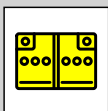
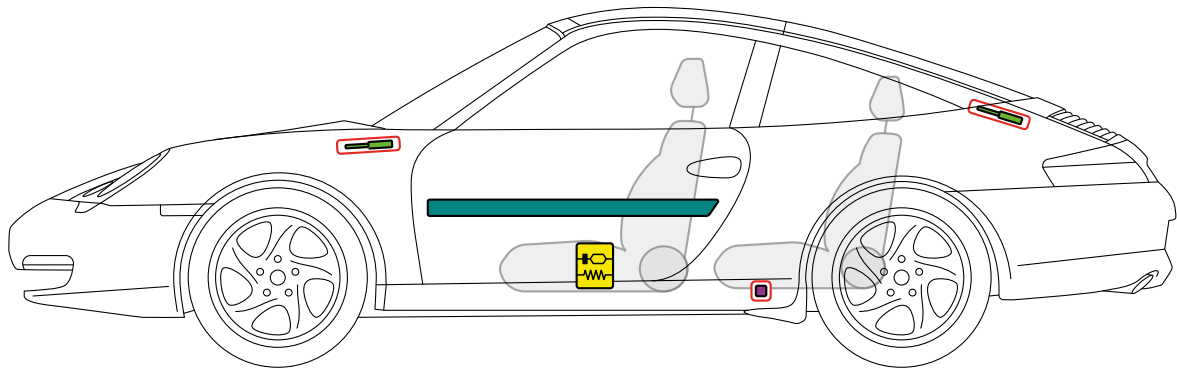
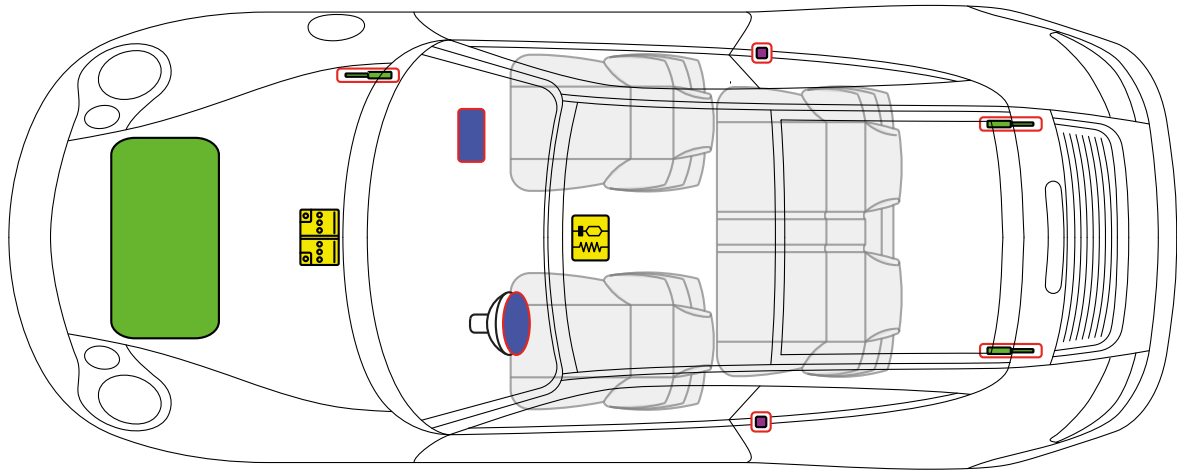

Batterie

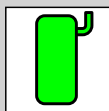

Kraftstofftank

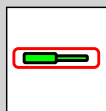

Gasdruck-
dämpfer



SRS
Steuergerät

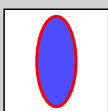

Airbag



Gurtstraffer

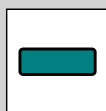

Karosserie-
verstärkung



Porsche AG, 996, Cabriolet, alle Derivate

PORSCHE MJ 1998 bis MJ 2005

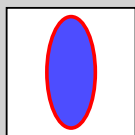
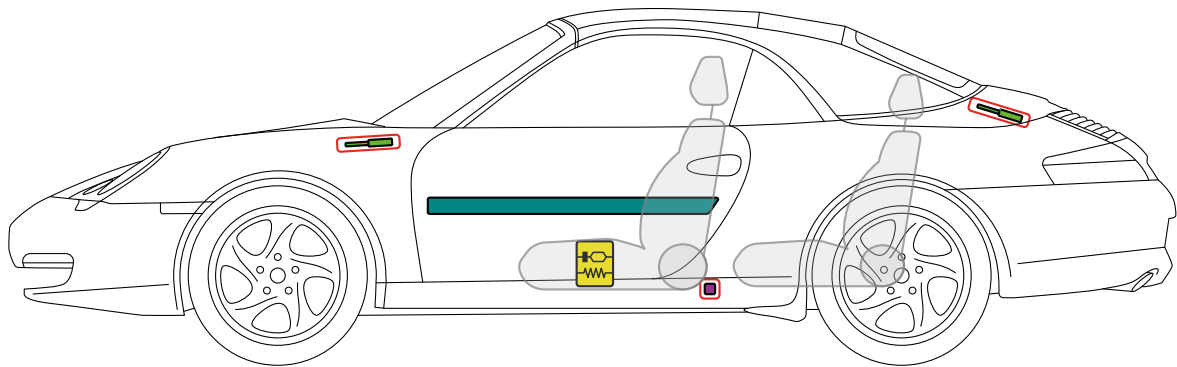
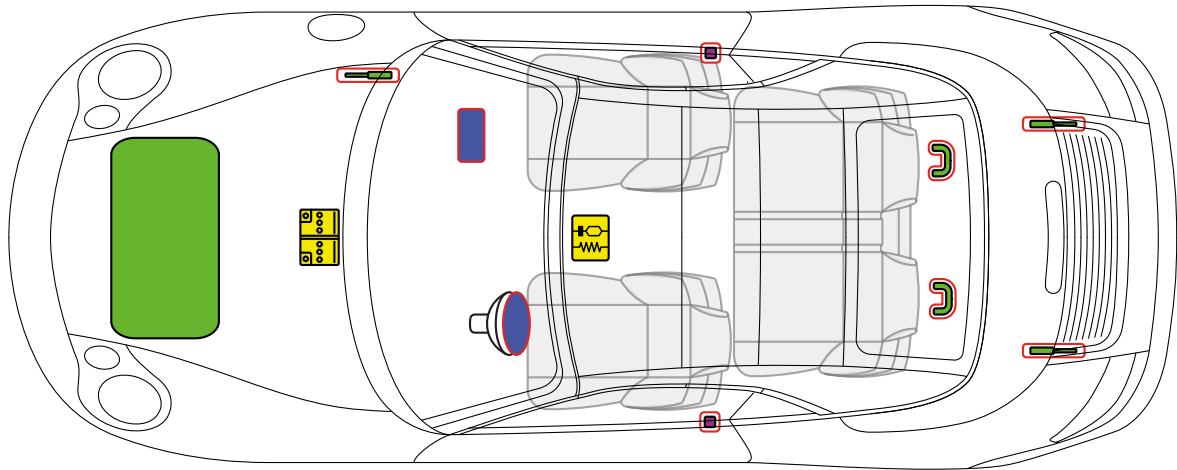

Airbag

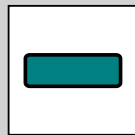

Karosserie-
verstärkung

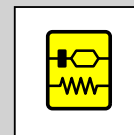

Steuergerät

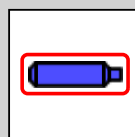

Gasgenerator

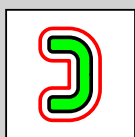

Überrollschutz

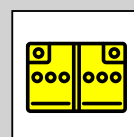

Batterie



Gurtstraffer

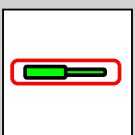

Gasdruck-
dämpfer

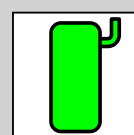

Kraftstofftank



Porsche AG, 980, Carrera GT, Cabriolet, alle Derivate

PORSCHE MJ 2003 bis MJ 2006

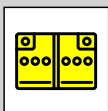
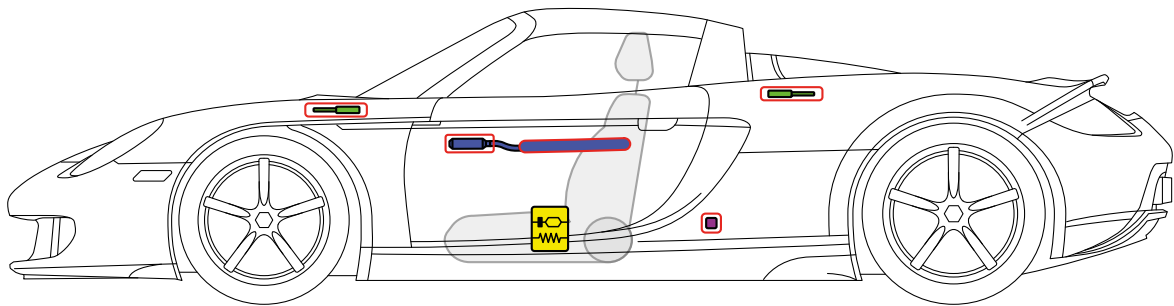
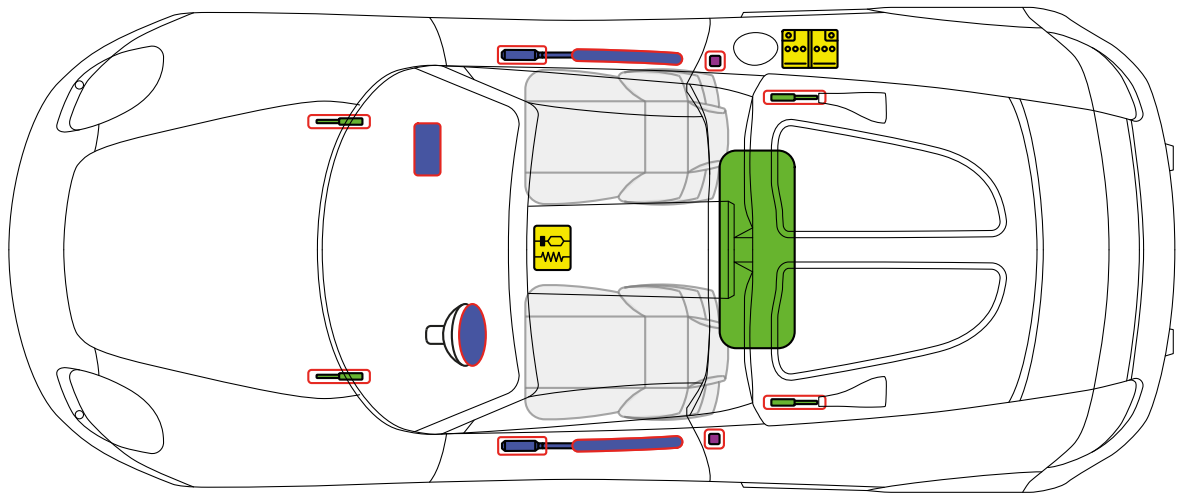

Batterie

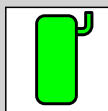

Kraftstofftank

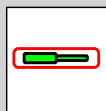

Gasdruck-
dämpfer



SRS
Steuergerät

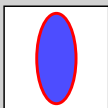

Airbag



Gurtstraffer

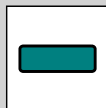

Karosserie-
verstärkung

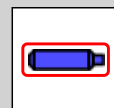

Gasgenerator